

Control and signaling units Ø 22

Harmony[®] XB5 Plastic

Catalog

November 2014



How can you fit a 6000-page catalog in your pocket ?

Schneider Electric provides you with the complete set of industrial automation catalogs all on a handy USB key for PC or in an application for tablets



Digi-Cat, a handy USB key for PC



- > Convenient to carry
- > Always up-to-date
- > Environmentally friendly
- > Easy-to-share format



Contact your local representative to get your own Digi-Cat



e-Library, the app for tablets

If you have an iPad®:

- > Go to the App Store and search for e-Library
- > or scan the QR code



If you have an Android tablet:

- > Go to the Google Play Store™ and search for eLibrary
- > or scan the QR code

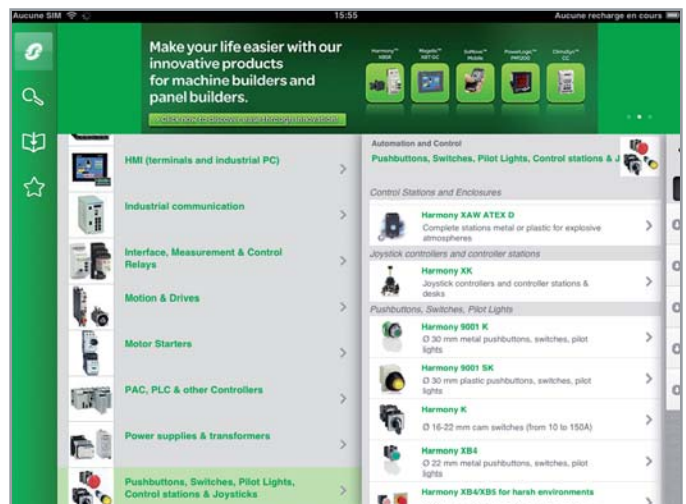

General contents

Harmony® XB5 plastic

Selection guide page 4

■ General









□ Presentation page 4
□ Description page 5

■ Installation





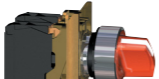

□ Contact mounting - Contact sequence page 12

■ References

- Spring return, pushbuttons page 14
- Illuminated pushbuttons, spring return
 - With integral LED page 19
 - With BA 9s base fitting page 21
- Multiple-headed pushbuttons, spring return page 22
- Mushroom head pushbuttons, spring return type or latching type page 24
- Emergency stop and Emergency switching off functions page 26
- General safe stop page 27
- Pushbuttons and Illuminated pushbuttons, push-push page 28
- Pushbuttons, “push-turn to release” page 29
- Selector switches with standard handle or with long handle page 30
- Key switches page 32
- Selector switches with knurled knob - Toggle switches page 33
- Illuminated selector switches, with standard handle, and integral LED page 34
- Pilot lights
 - With integral LED page 36
 - Integral LED and with BA 9s base fitting page 37
- Specific functions
 - Manual overload reset pushbuttons page 38
 - Heads for potentiometer, hour counters, annunciators and fuse carrier page 38
 - Joystick controllers with screw clamp terminal connections page 39
- Contact and illuminated functions (blocks & bodies)
 - With screw clamp terminal connections page 40
 - With spring clamp terminal connections page 42
 - For printed circuit board page 43
 - With Faston or plug-in connectors page 44
- Body/contact assemblies and light blocks
 - With integral LED page 46
 - With BA 9s base fitting page 50
- Accessories
 - For heads page 52
 - For pushbuttons page 62
 - Legends and legend holders page 56
- **Product reference index** page 11

Type of products	Pilot lights	Pushbuttons, selector switches and pilot lights			Biometric switches	
						
						
						
						
Description of range	<ul style="list-style-type: none"> LED pilot lights 	<ul style="list-style-type: none"> Pushbuttons Multiple-headed pushbuttons Emergency Stop pushbuttons Selector switches and key switches Illuminated pushbuttons Pilot lights 			<ul style="list-style-type: none"> Fingerprint readers 24V ~ Stand-alone biometric switches Stand-alone USB biometric switches USB biometric switches dedicated to Schneider HMI (1) 	
Features	Products	Monolithic, compact, low consumption	Complete units or sub-assemblies (body + head)			Monolithic
	Bezel	Double insulated	Double insulated (3)	Metal, chromium plated or black	Double insulated	Double insulated, dark grey
	Shape of head	Circular	Circular, square or rectangular	Circular	Circular or square	–
Drilling or cut-out for fixing		Ø 8 mm and Ø 12 mm/0.315 in. and 0.472 in.	Ø 16 mm/0.630 in.	Ø 22 mm/0.866 in.		
Degree of protection	Conforming to IEC 60529	IP 40 IP 65 with seal	IP 65	IP 66 IP 69K (Selector switches and key switches, multiple-headed pushbuttons and Emergency Stop pushbuttons with bellows)	IP 65 (control button)	
	Conforming to UL 508 and CSA C22-2 N° 14	–	Enclosure type 4, 4X and 13			Enclosure type 12
Cabling		Tags for 2.8 x 0.5 mm/0.110 x 0.020 in. connectors or threaded connector	Faston connectors Solder pins for printed circuit boards (3) Fast connector socket (4)	Spring clamp terminal connections Screw clamp terminal connections Faston connectors Connector With adaptor for printed circuit board	Cable or connectors	
Mounting	Panel thickness	1...8 mm/0.039...0.315 in.	1...6 mm/0.039...0.236 in.			
Type references		XVLA	XB6, XB6E	XB4	XB5	XB5S

(1) Compatible with Magelis iPC, STU, OT, GXO, GT (except GT1000 series), GK, GH, and GTO models.
 (2) Wireless and batteryless pushbutton and receiver ready-paired at the factory.

Wireless and batteryless pushbuttons	Pushbuttons, selector switches and pilot lights	Joystick controllers	Pushbuttons, selector switches and pilot lights	Cam switches				
								
								
								
								
Description of range	<ul style="list-style-type: none"> Wireless and batteryless pushbuttons and rope pull switch Configurable receivers Access point Relay-antenna Mobile handy box or plastic boxes for wall mounting 	<ul style="list-style-type: none"> 2 or 4 direction Stay put or spring return 	<ul style="list-style-type: none"> Pushbuttons Emergency Stop buttons Selector switches and key switches Illuminated pushbuttons Pilot lights 	<ul style="list-style-type: none"> Switches Stepping switches Reversing and changeover switches Ammeter switches Voltmeter switches Reversing switches Star-delta and reversing star-delta switches Pole change switches 				
Features	Products	Ready-to-use packs (2) and "components" range	Monolithic	Complete units or sub-assemblies (body + head with lever)	Complete units or sub-assemblies (body + head)	Complete units or sub-assemblies (body + front panel + head)		
	Bezel	Metal, chromium plated or double insulated, black	Double insulated, dark grey (or white for pilot lights)	Metal, chromium plated	Double insulated, black	Metal, chromium plated or double insulated, black		
	Shape of head	Transmitter with circular head	Circular	Circular	Hexagonal	Square		
Drilling or cut-out for fixing		Ø 22 mm/0.866 in.			Ø 30 mm/1.181 in.	Ø 16 or Ø 22 mm/0.630 or 0.866 in.: series K10 Ø 22 mm/0.866 in. and multifixing: series K1/K2 4 holes, 48 or 68 centres: series K30...K150		
Degree of protection	Conforming to IEC 60529	IP 65	IP 65 (control buttons and pilot lights) IP 54 (Emergency switching off pushbuttons)	IP 65	IP 66	IP 65: series K10 IP 40, IP 65 with seal: series K1/K2 IP 40: series K30...K150		
	Conforming to UL 508 and CSA C22-2 N° 14	Enclosure type 12	Enclosure type 3 (pushbuttons and Emergency stop) and 4 (pilot lights)	Enclosure type 4, 4X and 13	Enclosure type 4 and 13 (9001K) Enclosure type 4, 4X, 13 (9001SK)	–		
Cabling		Wireless (transmitter) Through cable (receiver)	Screw and captive clamp terminal connections Faston clip connections (pilot lights)	Screw and captive clamp terminal connections				
Mounting	Panel thickness	1...6 mm/0.039...0.236 in.				0.5...6 mm/0.020...0.236 in. (depending on model)		
Type references		XB5R, XB4R	XB7	XD4PA	XD2GA	XD5PA	9001K, 9001SK	K10, K1, K2, K30, K50, K63, K115, K150

(3) For Harmony® XB6 only.
 (4) For Harmony® XB6E only.

Presentation

The Harmony® XB5 range of plastic control and signaling units combines simplicity of installation and flexibility. It provides a solution for industrial applications demanding a high resistance to chemical agents and also provides double electrical insulation.

- This range includes:
 - Pushbuttons and switches designed for Start/Stop control of machines and installations, adjustment and parametering (contact functions): Pushbuttons, selector/key switches, Emergency stop or Emergency switching off functions, multiple-headed pushbuttons
 - Pilot lights designed for visual signaling (signaling functions)
 - Illuminated pushbuttons designed for control and signaling (contact functions + signaling functions)
- These products are shown on the following pages in two forms:
 - Complete units with black plastic bezel
 - Sub-assemblies for user assembly (body sub-assemblies and head sub-assemblies with black plastic bezel)
- The pushbutton and switch control offer (illuminated and non-illuminated) is both broad and comprehensive:
 - Flush, projecting, recessed, booted, spring return, push-pull, marked or unmarked pushbuttons
 - Emergency stop trigger action and mechanically latching pushbuttons (conforming to standards EN/IEC 60204-1 and EN/ISO 13850)
 - Emergency switching off mechanically latching pushbuttons (conforming to standard IEC 60364-5-53)
 - Selector switches with standard handle, long handle or knurled knob, key switches
 - Controllers
 - Wide choice of legends and legend holders
 - Wide choice of head colors
 - Wide choice of accessories and spare parts
- The pilot light signaling offer includes pilot lights with integral LED and pilot lights for BA 9s base fitting bulbs. The two types of pilot light are for direct supply or via integral transformer.
- The XB5 range also includes innovative complementary offers:
 - Multiple-headed pushbuttons
 - Control and signaling units for harsh applications
 - Wireless and batteryless pushbuttons
 - Biometric switches

Installation

- Harmony® XB5 products are both simple and quick to install:
 - Mounting by single installer (self-maintaining of the head in its cut-out)
 - Clip-together component system (head, body, contact blocks and LED)
 - Fixing by a single nut (anti-rotation plate)
 - Anti-loosening system for screw clamp terminals of contact blocks (thus avoiding frequent checking/retightening).
- Various types of connection are available: Screw clamp, connector, Faston connector, spring terminal or for printed circuit board.

Environment

- The performance features of the Harmony® XB5 range meet the most demanding international standards and approvals:
 - EN/IEC 60947-1, EN/IEC 60947-5-1, EN/IEC 60947-5-4 and EN/IEC 60947-5-5
 - UL 508, CSA C22-2 n° 14, GB 14048.5
 - International certifications: UL, CSA, CCC, GOST
 - Marine certifications: BV, RINA, LROS, DNV, GL
- The range includes products for use in difficult industrial environments, due to:
 - Their high degree of protection for severe environments (IP 66/IP 69K)
 - Their resistance to high pressure cleaning
 - Their "all climates" TH compatibility
 - A wide choice of contact blocks with various breaking capacities (low, standard or high power switching)

For more technical information, please refer to our website www.schneider-electric.com.

Control and signaling units Ø 22

Harmony® XB5, plastic

Pushbuttons, switches and pilot lights

Description

The Ø 22 range of plastic (double insulated) control and signaling units comprises:

Complete units, XB5A



Pushbuttons and switches

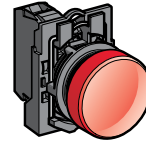

Pilot lights

Sub-assemblies, ZB5A

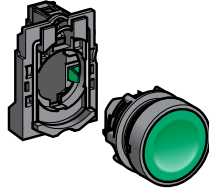

Pushbuttons and switches:
body + head
sub-assemblies

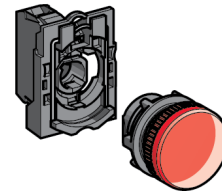

Pilot lights:
body + head
sub-assemblies

Component parts and accessories, ZB

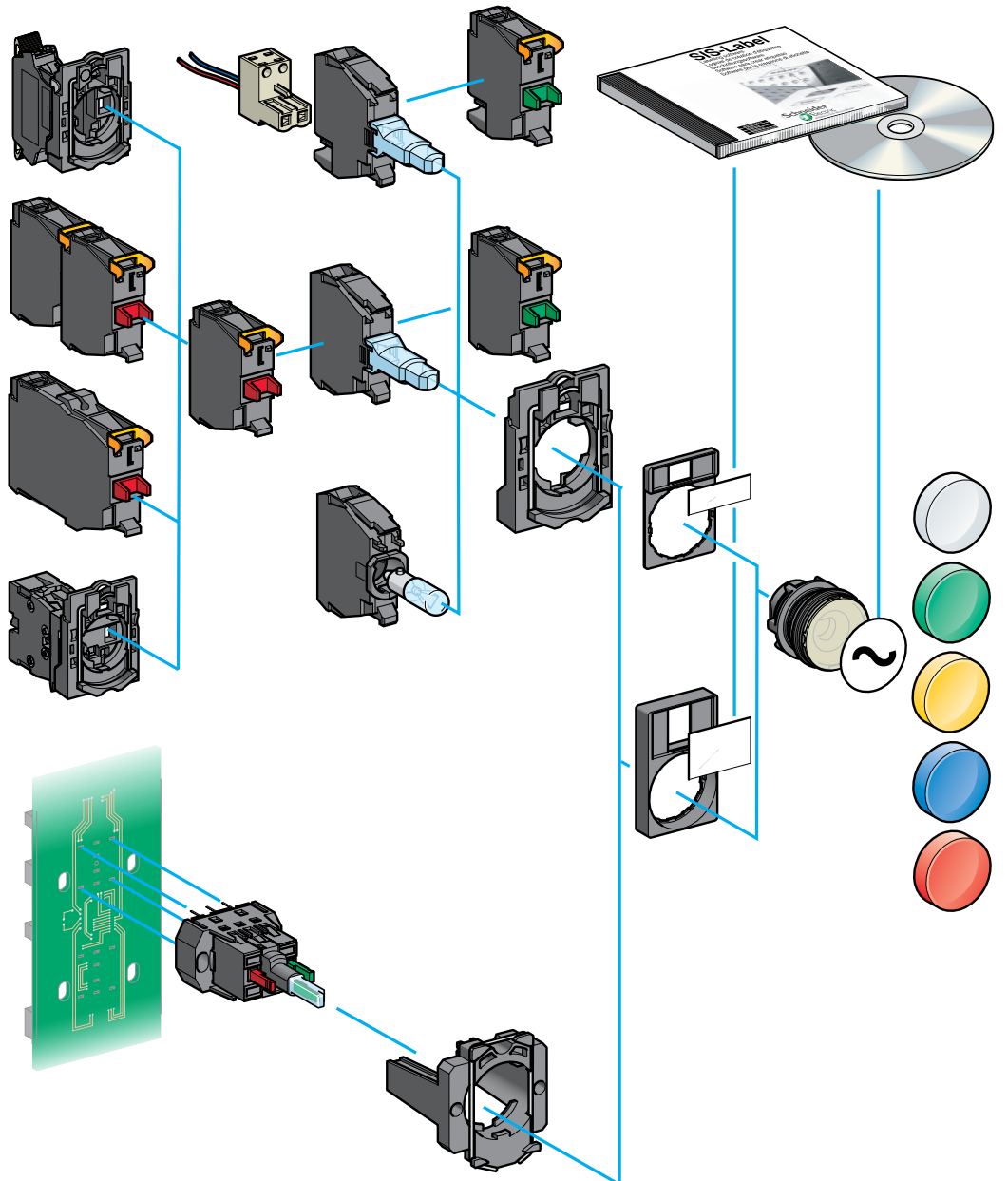

Control and signaling units Ø 22

Harmony® XB5, plastic

Pushbuttons, switches and pilot lights:
complete units, XB5A

Complete units

Contact functions

Pushbuttons, spring return



Flush push, unmarked
XB5AA●1/AA42
see page 14



Flush push, marked
XB5AA3311/AA33●1
see page 18



Projecting push, marked
XB5AL4322
see page 18



Booted flush push
XB5AP●1/AP42
see page 17



Projecting push, unmarked
XB5AL42
see page 16

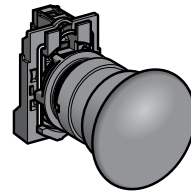

Ø 40
/1.575 in.

Mushroom head
XB5AC21
see page 24

Multiple-headed pushbuttons, spring return

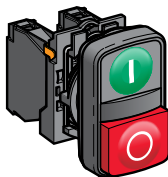

Double-headed
XB5AL73415
see page 22



Triple-headed
XB5AA731327/XB5AA711237
see page 23

Emergency Stop or Emergency switching off mushroom head pushbuttons, Ø 40/1.575 in.

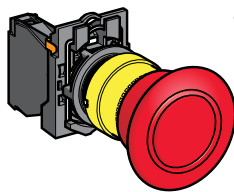

Ø 40
/1.575 in.

Push-pull (EN/ISO 13850)
XB5AT845
see page 26

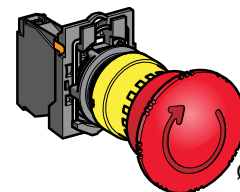

Ø 40
/1.575 in.

Turn to release (EN/ISO 13850)
XB5AS8●4
see page 26

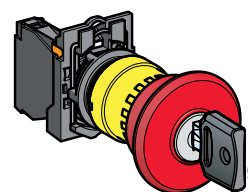

Ø 40
/1.575 in.

Key release (EN/ISO 13850)
XB5AS9445
see page 26

Emergency stop trigger action and mechanical latching

Selector switches and key switches

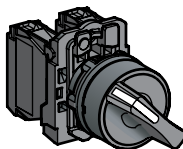

Standard handle, black
XB5AD●●
see page 30



Long handle, black
XB5AJ●●
see page 31

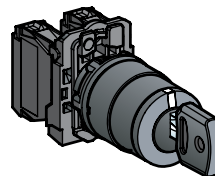

Key switch
XB5AG●●
see page 32

Control and signaling units Ø 22

Harmony® XB5, plastic

Pushbuttons, switches and pilot lights:
complete units, XB5A

Complete units

(continued)

Pilot lights

Signaling functions

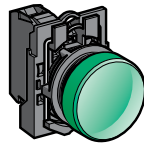

Integral LED

XB5AVB●/AVG●/AVM●
see page 36



For bulb with BA 9s base fitting

Direct supply
XB5AV6●
see page 37

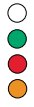
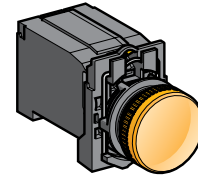

Via integral transformer
XB5AV3●/AV4●
see page 37

Combined functions (contact and signaling)

Illuminated pushbuttons, spring return, flush push



Integral LED

XB5AW3●B5/AW3●G5/AW3●M5
see page 19



For bulb with BA 9s base fitting

Direct supply
XB5AW3●65
see page 21

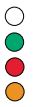
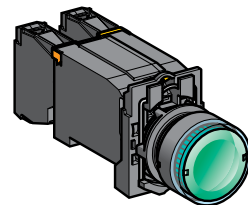

Via integral transformer
XB5AW3●35/AW3●45
see page 21

Double-headed pushbuttons, spring return, and pilot light block

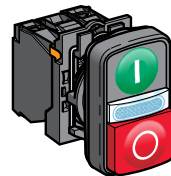

Integral LED

XB5AW73731●5
see page 22

Illuminated selector switches, standard handle

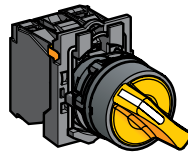

Integral LED

XB5AK12●●5, XB5AK13●●5
see page 34

Control and signaling units Ø 22

Harmony® XB5, plastic

Pushbuttons, switches and pilot lights:
sub-assemblies, ZB5A

Non illuminated units for user assembly

For pushbuttons, spring return, unmarked

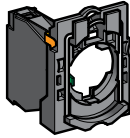

Screw clamp terminals
ZB5AZ10●/AZ141
see page 40

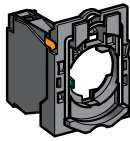

Faston
ZB5AZ10●3
see page 44

For pushbuttons, spring return, marked

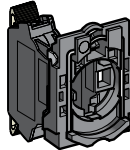

Spring clamp terminals
ZBE10●5
ZB5AZ10●5
see page 42

For multiple-headed pushbuttons, spring return

For "push-push to release" pushbuttons

For "push-turn to release" pushbuttons

Contact functions

Body sub-assemblies

Head sub-assemblies



Flush push without cap/with set of 6 caps
ZB5AA0/AA9
see page 14

Flush push
ZB5AA●
see page 14

Flush push for insertion of legend
ZB5AA●8
see page 14

Flush push, cap mounted/not mounted
ZB5CA0/CA●
see page 14



Projecting
ZB5AL●
see page 16



Recessed push
ZB5AA●
see page 15



Booted flush push, for insertion of legend
ZB5AP●●/AP●S
see page 17

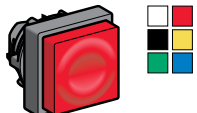

Projecting or recessed push
ZB5CA●/CL●
see page 15



Flush push
ZB5AA●3●/AA●4●
see page 18



Projecting push
ZB5AL●
see page 18



Flush push
ZB5CA●3●/CA●9●
see page 18

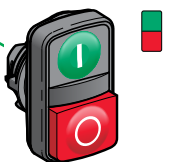

Double-headed
ZB5AA7●●●/AA79
ZB5AL734●
see page 22



Triple-headed
ZB5AA7313●, ZB5AA711●●
ZB5AA72124, ZB5AA791
see page 23



Flush push (caps mounted/not mounted)
ZB5AH●●/CH●●
see page 28



Projecting push
ZB5AH●
see page 28



Flush push (caps mounted/not mounted)
ZB5CH0/CH0●
see page 28

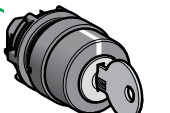

Key switches
ZB5AFD●
see page 29



Knurled knob (1)
ZB5AF
see page 29

(1) Knob positions

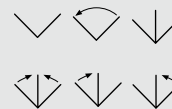

Control and signaling units Ø 22

Harmony® XB5, plastic

Pushbuttons, switches and pilot lights:
sub-assemblies, ZB5A

Pilot lights for user assembly

Signaling functions

Body sub-assemblies with integral LED

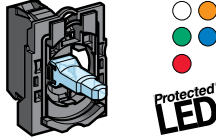

Connection: screw clamp terminals
ZB5AVB●/AVG●/AVM●
see page 48

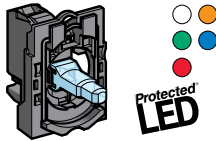

Connection: plug-in connector
Please consult our Customer Care Centre

Head sub-assemblies



With lens fitted (insertion of legend)
ZB5AV0●3/AV0●3E, see page 36



With lens fitted
ZB5CV0●3, see page 36



With 5 lens caps (not fitted) for insertion of legend
ZB5AV003/AV0●3●, see page 36



With 5 separate lens caps, not fitted
ZB5CV003, see page 36

Body sub-assemblies for BA 9s bulb

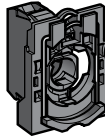

Direct supply
Connection: screw clamp terminals
ZB5AV6, see page 51

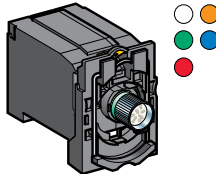

Via integral transformer
Connection: screw clamp terminals
ZB5AV●/AV3D●/AV5D●
see page 51

Head sub-assemblies



With lens fitted
ZB5AV0●, see page 37

Illuminated pushbuttons for user assembly

Combined functions (contact and signaling)

For illuminated pushbuttons, spring return

Body sub-assemblies for BA 9s bulb

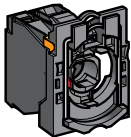

Direct supply
Connection: screw clamp terminals
ZB5AW06●, see page 50

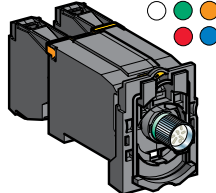

Via integral transformer
Connection: screw clamp terminals
ZB5AW03●/AW04●/AW05●
see page 50

Head sub-assemblies

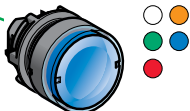

Flush
ZB5AW3●/AW3●S, see page 20

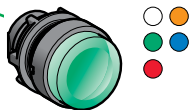

Projecting
ZB5AW1●/AW1●S, see page 20

Illuminated pushbuttons for user assembly

For illuminated pushbuttons, spring return

Body sub-assemblies with integral LED

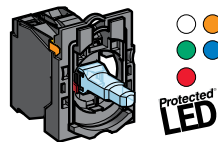

Connection: screw clamp terminals
ZB5AW0B●●/AW0G●●/AW0M●●
see page 46

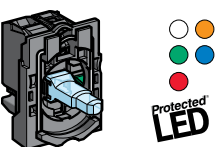

Connection: plug-in connector
Please consult our Customer Care Centre

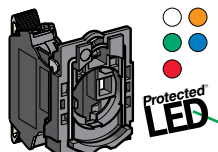

Connection: spring clamp terminals
ZBV ●●5
see page 42

For double-headed pushbuttons, spring return, with pilot light

For illuminated, mushroom head pushbuttons, latching

For illuminated mushroom head pushbuttons

- Emergency Stop with trigger action and mechanical latching

or

- Emergency switching off with mechanical latching only

For illuminated "push-push to release" pushbuttons

For illuminated selector switches, standard handle

Combined functions (contact and signaling) (continued)

Head sub-assemblies

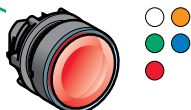

Flush push
Flush push with illuminated ring
ZB5AW3●3/AW3●3S/AW9●3
see page 20



Flush push
for insertion of legend
ZB5AA●8
see page 14



Booted flush push
ZB5AW5●3
see page 20



Projecting push
ZB5AW1●3/AW1●3S
see page 20

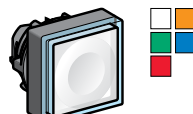

Flush or projecting push
Flush or projecting push for insertion of legend
ZB5CW3●3/CW1●3
see page 20



Double-headed (flush/flush push) + central pilot light
Double-headed (flush/projecting push) + central pilot light
ZB5AW7A17●●, ZB5AW7A374●●, ZB5AW7A9, see page 22
ZB5AW7L374●●, see page 22

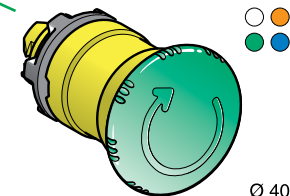

Turn to release
ZB5AW7●3, see page 25

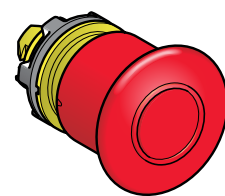

Push-pull with mechanical state indicator (EN/ISO 13850)
ZB5AT8643M
see page 26

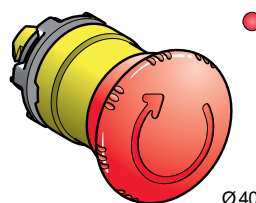

Turn to release (IEC 60364-5-53)
ZB5AW743
see page 27



Flush or projecting "push-push to release"
ZB5AH0●3/AH●3
see page 28

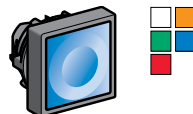

Flush "Push-push to release"
ZB5CH3●3
see page 28



Standard handle (1)
ZB5AK1●●3
see page 35

(1) Handle positions



Control and signaling units Ø 22

Harmony® XB5 plastic
Contact mounting - Contact sequence

Maximum recommended configurations guaranteeing achievement of catalogue characteristics

Unit type (complete units XB5B, heads ZB5B)	Pushbuttons, spring return XB5AA●, ZB5AA●, (except ZB5AA●8) XB5AC●, ZB5AC●, XB5AL●, ZB5AL●, XB5AP●, ZB5AP●, ZB5AR● Triple-headed pushbuttons XB5AA731327, XB5AA711137, ZB5AA7313●, ZB5AA7111●, ZB5AA72124, ZB5AA791	Double-headed pushbuttons XB5AL73415, ZB5AA712●, ZB5A●734●, ZB5AA79	Illuminated pushbuttons, spring return XB5AW●, ZB5AW●, ZB5AA●8 Double-headed pushbuttons + pilot light block XB5AW73731●5, ZB5AW7A17●●, ZB5AW7●374●, ZB5AW7A9	
Solution using single contacts				
Solution using single and double contacts				
Maximum recommended configurations	Single contacts Double contacts + Single contacts Light block	9 3 + 3 -	6 2 + 2 -	6 2 + 2 1

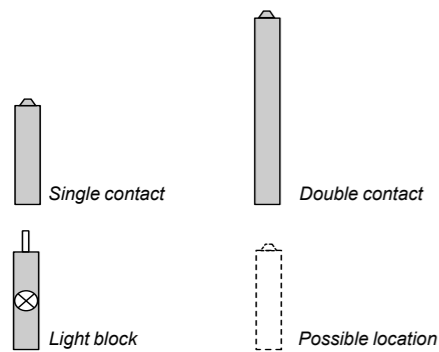

Possible configurations for high power switching contacts (1) (2)

High power switching contact blocks with screw clamp terminal connections : ZBE501, ZBE502, ZBE503, ZBE504 and ZBE505
High power switching contact blocks with connection by Faston connectors ZBE5013, ZBE5023, ZBE5033, ZBE5043 and ZBE5053

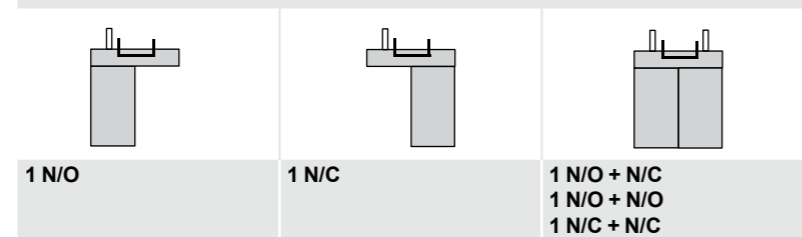

(1) The configurations are not upgradable and cannot be combined with other types of contact and signaling functions.
(2) High power switching contacts are not compatible with Harmony triple-headed pushbuttons.

Sequence of contacts fitted to selector switch bodies



Emergency stop or Emergency switching off XB5AT●, ZB5AT●, XB5AS●, ZB5AS●	Selector switches XB5AD●, ZB5AD●, ■ Standard handle XB5AJ●, ZB5AJ●, ■ Long handle ZB5AD●9, ■ Key switch XB5AG●, ZB5AG●		Illuminated selector switches with standard handle XB5AK●, ZB5AK●	Toggle switches ZB5AD●8 Pushbuttons, push-turn to release, knurled operator ZB5AF●, or lockable ZB5FAD●	Pushbuttons, push-push ZB5AH●	Illuminated pushbuttons, push-push ZB5AH●3 ZB5AW743 Illuminated Emergency Stop ZB5AT8643M
4 2 + 0 -	4 1 + 2 -	5 2 + 1 -	4 1 + 2 -	6 2 + 2 1	3 - - -	2 - - 1

Sequence of contacts fitted to selector switch bodies





Unit type	Selector switches					
	2-position	3-position				
Push	Position Top					
	Position Bottom					
Contacts	Location	L C R	L C R	L C R	L C R	L C R
	State	0 0 0	1 1 1	1 1 0	0 0 0	0 1 1
	N/O	□ □ □	■ ■ ■	■ ■ □	□ □ □	□ ■ ■
	N/C	■ ■ ■	□ □ □	□ □ ■	■ ■ ■	■ □ □



L left, C centre, R right
□ open, ■ closed

Assembly of other products using:
body/contact assemblies: see page 40
accessories: see page 52

Pushbuttons with flush push ⁽¹⁾						
Screw clamp terminal connections (Schneider Electric anti-loosening system)						
Shape of head	Type of push	Type of contact		Color of push	Reference	Weight kg/lb
		 N/O	 N/C			

Complete units						
	Flush	1	-	White	XB5AA11 (ZB5AZ101 + ZB5AA1)	0.037/0.082
				Black	XB5AA21 (ZB5AZ101 + ZB5AA2)	0.037/0.082
				Green	XB5AA31 (ZB5AZ101 + ZB5AA3)	0.037/0.082
				Yellow	XB5AA51 (ZB5AZ101 + ZB5AA5)	0.037/0.082
				Blue	XB5AA61 (ZB5AZ101 + ZB5AA6)	0.037/0.082
				Red	XB5AA42 (ZB5AZ102 + ZB5AA4)	0.037/0.082
		-	1			

Heads only, circular						
	Without cap ⁽²⁾			-	ZB5AA0	0.022/0.049
	Flush, with set of 6 colored caps ⁽³⁾			6 colors	ZB5AA9	0.027/0.060
	Flush			White	ZB5AA1	0.018/0.040
				Black	ZB5AA2	0.018/0.040
				Green	ZB5AA3	0.018/0.040
				Red	ZB5AA4	0.018/0.040
				Yellow	ZB5AA5	0.018/0.040
				Blue	ZB5AA6	0.018/0.040
				Grey	ZB5AA8	0.018/0.040
					Flush with transparent cap for insertion of legend ⁽⁴⁾	
Green	ZB5AA38	0.018/0.040				
Red	ZB5AA48	0.018/0.040				
Yellow	ZB5AA58	0.018/0.040				
Blue	ZB5AA68	0.018/0.040				
	Flush (high bezel)			White	ZB5AA14	0.020/0.044
				Black	ZB5AA24	0.020/0.044
				Green	ZB5AA34	0.020/0.044
				Red	ZB5AA44	0.020/0.044
				Yellow	ZB5AA54	0.020/0.044
				Blue	ZB5AA64	0.020/0.044

Heads only, square						
	Without cap ⁽²⁾			-	ZB5CA0	0.022/0.049
	Flush			White	ZB5CA1	0.019/0.042
				Black	ZB5CA2	0.019/0.042
				Green	ZB5CA3	0.019/0.042
				Red	ZB5CA4	0.019/0.042
				Yellow	ZB5CA5	0.019/0.042
				Blue	ZB5CA6	0.019/0.042

(1) Recommended maximum number of contacts constituting the body (fixing collar and contact) associated with the head, see page 12
 (2) Colored cap to be ordered separately: see page 52.
 (3) Head supplied with 6 different colored caps (White, Black, Green, Red, Yellow, Blue) not fitted.
 (4) For legend ordering information, see page 61.



Assembly of other products using:
body/contact assemblies: see page 40
accessories: see page 52



ZB5AA16

Pushbuttons with recessed push (1) High guard

Shape of head	Type of push	Color	Reference	Weight kg/lb
Heads only, circular				
	Recessed (high guard)	White	ZB5AA16	0.020/0.044
		Black	ZB5AA26	0.020/0.044
		Green	ZB5AA36	0.020/0.044
		Red	ZB5AA46	0.020/0.044
		Yellow	ZB5AA56	0.020/0.044
		Blue	ZB5AA66	0.020/0.044







ZB5CA16

Heads only, square				
	Recessed (high guard)	White	ZB5CA16	0.012/0.026
		Black	ZB5CA26	0.012/0.026
		Green	ZB5CA36	0.012/0.026
		Red	ZB5CA46	0.012/0.026
		Yellow	ZB5CA56	0.012/0.026
		Blue	ZB5CA66	0.012/0.026

(1) Recommended maximum number of contacts constituting the body (fixing collar and contact) associated with the head, see page 12.

Assembly of other products using:
body/contact assemblies: see page 40
accessories: see page 52

Pushbuttons with projecting push ⁽¹⁾						
Screw clamp terminal connections (Schneider Electric anti-loosening system)						
Shape of head	Type of push	Type of contact		Color of push	Reference	Weight kg/lb
						
		N/O	N/C			
Complete units						
	Projecting	-	1	Red	XB5AL42 (ZB5AZ102 + ZB5AL4)	0.038/0.084
Heads only, circular						
	Projecting			White	ZB5AL1	0.019/0.042
				Black	ZB5AL2	0.019/0.042
				Green	ZB5AL3	0.019/0.042
				Red	ZB5AL4	0.019/0.042
				Yellow	ZB5AL5	0.019/0.042
				Blue	ZB5AL6	0.019/0.042
Heads only, square						
	Projecting			White	ZB5CL1	0.021/0.046
				Black	ZB5CL2	0.021/0.046
				Green	ZB5CL3	0.021/0.046
				Red	ZB5CL4	0.021/0.046
				Yellow	ZB5CL5	0.021/0.046
				Blue	ZB5CL6	0.021/0.046



XB5AL42



ZB5AL3



ZB5CL1

(1) Recommended maximum number of contacts constituting the body (fixing collar and contact) associated with the head, see page 12.

Assembly of other products using:
 body/contact assemblies: see page 40
 combined sub-assemblies: see page 46
 accessories: see page 52

Pushbuttons with booted head (1)

Screw clamp terminal connections (Schneider Electric anti-loosening system)

Shape of head	Type of push	Type of contact		Color of push	Reference	Weight kg/lb
		N/O	N/C			



XB5AP51

Complete units						
	Booted, clear silicone (color of push unobscured)	1	–	Black	XB5AP21 (ZB5AZ101 + ZB5AP2)	0.039/0.086
		–	–	Green	XB5AP31 (ZB5AZ101 + ZB5AP3)	0.039/0.086
		–	–	Yellow	XB5AP51 (ZB5AZ101 + ZB5AP5)	0.039/0.086
		–	–	Blue	XB5AP61 (ZB5AZ101 + ZB5AP6)	0.039/0.086
		–	1	Red	XB5AP42 (ZB5AZ102 + ZB5AP4)	0.039/0.086

Silicone booted heads only, with increased protection (IP 69K)

Shape of head	Type of push	Color of push	Reference	Weight kg/lb
	Clear boot (2) For insertion of protected legend within head (3)	White	ZB5AP18	0.023/0.051
		Green	ZB5AP38	0.023/0.051
		Red	ZB5AP48	0.023/0.051
		Yellow	ZB5AP58	0.023/0.051
		Blue	ZB5AP68	0.023/0.051



ZB5AP4

Shape of head	Type of push	Color of push	Reference	Weight kg/lb
	Clear boot (2)	White	ZB5AP1	0.014/0.031
		Black	ZB5AP2	0.014/0.031
		Green	ZB5AP3	0.014/0.031
		Red	ZB5AP4	0.014/0.031
		Yellow	ZB5AP5	0.014/0.031
		Blue	ZB5AP6	0.014/0.031



ZB5AP2S

Silicone booted heads only, standard for mouting with legend holder (IP 66)

Shape of head	Type of push	Color of push	Reference	Weight kg/lb
	Colored boot (4)	White	ZB5AP1S	0.021/0.046
		Black	ZB5AP2S	0.021/0.046
		Green	ZB5AP3S	0.021/0.046
		Red	ZB5AP4S	0.021/0.046
		Yellow	ZB5AP5S	0.021/0.046
		Blue	ZB5AP6S	0.021/0.046
	Clear membrane (4) For insertion of protected legend within head (3)	White	ZB5AP183	0.010/0.022
		Green	ZB5AP383	0.010/0.022
		Red	ZB5AP483	0.010/0.022
		Yellow	ZB5AP583	0.010/0.022
		Blue	ZB5AP683	0.010/0.022



ZB5AP183

(1) Recommended maximum number of contacts constituting the body (fixing collar and contact) associated with the head, see page 12.







(2) Permissible panel thickness 1 to 5 mm, cannot be used with legend holders.



(3) To order a legend for insertion within the head, see page 61.

(4) Replacement of silicone protection element without dismantling head, see page 54.

Assembly of other products using:
body/contact assemblies: see page 40
accessories: see page 52

Pushbuttons with flush or projecting push (1) Screw clamp terminal connections (Schneider Electric anti-loosening system)

Shape of head	Type of push	Type of contact	Marking Text (color)	Color of push	Reference	Weight kg/lb
		 N/O	 N/C			
Complete units						
	Flush	1	–	"I" (White)	Green XB5AA3311 (ZB5AZ101 + ZB5AA331)	0.037/0.082
	Flush	–	1	"O" (White)	Red XB5AA4322 (ZB5AZ102 + ZB5AA432)	0.037/0.082
	Projecting	–	1	"O" (White)	Red XB5AL4322 (ZB5AZ102 + ZB5AL432)	0.037/0.082
	Flush (2)	1	–	↑ (Black)	White XB5AA3341 (ZB5AZ101 + ZB5AA334)	0.037/0.082
	Flush (2)	1	–	↓ (White)	Black XB5AA3351 (ZB5AZ101 + ZB5AA335)	0.037/0.082

Heads only, circular						
	Flush			"I" (White)	Green	ZB5AA331 0.018/0.040
				"I" (Black)	White	ZB5AA131 0.018/0.040
				"II" (White)	Green	ZB5AA336 0.018/0.040
				"II" (Black)	White	ZB5AA136 0.018/0.040
				"START" (White)	Green	ZB5AA333 0.018/0.040
				"START" (Black)	White	ZB5AA133 0.018/0.040
				"ON" (White)	Green	ZB5AA341 0.018/0.040
				"ON" (Black)	White	ZB5AA141 0.018/0.040
				"MARCHE" (White)	Green	ZB5AA342 0.018/0.040
				"MARCHE" (Black)	White	ZB5AA142 0.018/0.040
				 (White)	Black	ZB5AA245 0.018/0.040
				 (Black)	White	ZB5AA145 0.018/0.040
				"O" (White)	Red	ZB5AA432 0.018/0.040
				"O" (Black)	Black	ZB5AA232 0.018/0.040
				"ARRET" (White)	Red	ZB5AA433 0.018/0.040
				"ARRET" (Black)	Black	ZB5AA233 0.018/0.040
				"STOP" (White)	Red	ZB5AA434 0.018/0.040
				"STOP" (Black)	Black	ZB5AA234 0.018/0.040
				"OFF" (White)	Red	ZB5AA435 0.018/0.040
				"OFF" (Black)	Black	ZB5AA235 0.018/0.040
				UP (Black)	White	ZB5AA343 0.018/0.040
				Down (White)	Black	ZB5AA344 0.018/0.040
				↑ (Black) (2)	White	ZB5AA334 0.018/0.040
				↓ (White) (2)	Black	ZB5AA335 0.018/0.040

Heads only, square						
	Flush (2)			"I" (White)	Green	ZB5CA331 0.019/0.042
				"O" (White)	Red	ZB5CA432 0.019/0.042
				"+" (White)	Black	ZB5CA2934 0.019/0.042
				↑ (White)	Black	ZB5CA2912 0.019/0.042
				"R" (White)	Blue	ZB5CA6939 0.019/0.042

Heads only, circular						
	Projecting (2)			"O" (White)	Red	ZB5AL432 0.019/0.042
				"O" (Black)	Black	ZB5AL232 0.019/0.042
				"ARRET" (White)	Red	ZB5AL433 0.019/0.042
				"ARRET" (Black)	Black	ZB5AL233 0.019/0.042
				"STOP" (White)	Red	ZB5AL434 0.019/0.042
				"STOP" (Black)	Black	ZB5AL234 0.019/0.042
				"OFF" (White)	Red	ZB5AL435 0.019/0.042
				"OFF" (Black)	Black	ZB5AL235 0.019/0.042

(1) Recommended maximum number of contacts constituting the body (fixing collar and contact) associated with the head, see page 12.
(2) Product supplied with cap not clipped-in, allowing orientation through 360° in 90° steps.



XB5AA4322



ZB5AA331



ZB5AA432



ZB5CA432



ZB5AL232

Assembly of other products using:
body/contact assemblies: see page 40
accessories: see page 52

Control and signaling units Ø 22

Harmony® XB5, plastic

Illuminated pushbuttons, spring return, with integral LED

Illuminated pushbuttons with flush push (1)									
Screw clamp terminal connections (Schneider Electric anti-loosening system)									
Shape of head	Description	Type of contact		Supply voltage V	Color of push	Reference	Weight kg/lb		
		 N/O	 N/C						
Complete units - With plain lens									
 XB5AW31B5		Integral LED	1	1	~ 24 50/60 Hz	White	XB5AW31B5 (ZB5AW0B15 + ZB5AW313)	0.056/0.123	
						Green	XB5AW33B5 (ZB5AW0B35 + ZB5AW333)	0.056/0.123	
						Red	XB5AW34B5 (ZB5AW0B45 + ZB5AW343)	0.056/0.123	
						Orange	XB5AW35B5 (ZB5AW0B55 + ZB5AW353)	0.056/0.123	
						Blue	XB5AW36B5 (ZB5AW0B65 + ZB5AW363)	0.056/0.123	
					~ 110...120 50/60 Hz	White	XB5AW31G5 (ZB5AW0G15 + ZB5AW313)	0.056/0.123	
						Green	XB5AW33G5 (ZB5AW0G35 + ZB5AW333)	0.056/0.123	
						Red	XB5AW34G5 (ZB5AW0G45 + ZB5AW343)	0.056/0.123	
						Orange	XB5AW35G5 (ZB5AW0G55 + ZB5AW353)	0.056/0.123	
						Blue	XB5AW36G5 (ZB5AW0G65 + ZB5AW363)	0.056/0.123	
						~ 230...240 50/60 Hz	White	XB5AW31M5 (ZB5AW0M15 + ZB5AW313)	0.056/0.123
							Green	XB5AW33M5 (ZB5AW0M35 + ZB5AW333)	0.056/0.123
Red	XB5AW34M5 (ZB5AW0M45 + ZB5AW343)	0.056/0.123							
Blue	XB5AW36M5 (ZB5AW0M65 + ZB5AW363)	0.056/0.123							
 XB5AW34G5									

(1) Recommended maximum number of contacts constituting the body (fixing collar and contact) associated with the head, see page 12.









Assembly of other products using:
combined sub-assemblies: see page 46
accessories: see page 52

Control and signaling units Ø 22



Harmony® XB5, plastic

Illuminated pushbuttons, spring return, with integral LED





Illuminated pushbuttons with flush push (1)

Shape of head	Type of push	Color	Reference	Weight kg/lb
Heads only, circular (2) - With plain lens				
 	Flush	White	ZB5AW313	0.017/0.037
		Green	ZB5AW333	0.017/0.037
		Red	ZB5AW343	0.017/0.037
		Orange	ZB5AW353	0.017/0.037
		Blue	ZB5AW363	0.017/0.037
 	Flush with illuminated ring	White	ZB5AW913	0.016/0.035
		Green	ZB5AW933	0.016/0.035
		Red	ZB5AW943	0.016/0.035
		Orange	ZB5AW953	0.016/0.035
		Blue	ZB5AW963	0.016/0.035
 	Flush with clear boot (IP 69 K)	White	ZB5AW513	0.019/0.042
		Green	ZB5AW533	0.019/0.042
		Red	ZB5AW543	0.019/0.042
		Orange	ZB5AW553	0.019/0.042
		Blue	ZB5AW563	0.019/0.042
 	Flush for insertion of legend (3) (IP 69 K)	White	ZB5AA18	0.018/0.040
		Green	ZB5AA38	0.018/0.040
		Red	ZB5AA48	0.018/0.040
		Orange	ZB5AA58	0.018/0.040
		Blue	ZB5AA68	0.018/0.040







Heads only, circular (2) - With grooved lens (4)

 	Flush	White	ZB5AW313S	0.017/0.037
		Green	ZB5AW333S	0.017/0.037
		Red	ZB5AW343S	0.017/0.037
		Orange	ZB5AW353S	0.017/0.037
		Blue	ZB5AW363S	0.017/0.037

Heads only, square (2)

 	Flush (legend can be inserted)	White	ZB5CW313	0.023/0.051
		Green	ZB5CW333	0.023/0.051
		Red	ZB5CW343	0.023/0.051
		Orange	ZB5CW353	0.023/0.051
		Blue	ZB5CW363	0.023/0.051
 	Flush (high guard)	White	ZB5CW3136	0.014/0.031
		Green	ZB5CW3336	0.014/0.031
		Red	ZB5CW3436	0.014/0.031
		Orange	ZB5CW3536	0.014/0.031
		Blue	ZB5CW3636	0.014/0.031

Illuminated pushbuttons with projecting push (1)

Shape of head	Type of push	Color	Reference	Weight kg/lb
Heads only, circular (2) - With plain lens				
 	Projecting	White	ZB5AW113	0.018/0.040
		Green	ZB5AW133	0.018/0.040
		Red	ZB5AW143	0.018/0.040
		Orange	ZB5AW153	0.018/0.040
		Blue	ZB5AW163	0.018/0.040
 	Projecting	White	ZB5AW113S	0.017/0.037
		Green	ZB5AW133S	0.017/0.037
		Red	ZB5AW143S	0.017/0.037
		Orange	ZB5AW153S	0.017/0.037
		Blue	ZB5AW163S	0.017/0.037
Heads only, square (2)				
 	Projecting (legend can be inserted)	White	ZB5CW113	0.024/0.053
		Green	ZB5CW133	0.024/0.053
		Red	ZB5CW143	0.024/0.053
		Orange	ZB5CW153	0.024/0.053
		Blue	ZB5CW163	0.024/0.053

(1) Recommended maximum number of contacts constituting the body (fixing collar and contact) associated with the head, see page 12.

(2) Only for use with bodies comprising a light source with integral LED.

(3) For legend ordering information, see page 61.

(4) For use in bright ambient light conditions (for example, outdoors in sunlight).



ZB5AW313



ZB5AW363



ZB5CW313



ZB5CW3136



ZB5AW143











ZB5CW143

Assembly of other products using:
combined sub-assemblies: see page 46
accessories: see page 52

Control and signaling units Ø 22

Harmony® XB5, plastic

Illuminated pushbuttons, spring return,
with BA 9s base fitting

Illuminated pushbuttons with flush push ⁽¹⁾															
Screw clamp terminal connections (Schneider Electric anti-loosening system)															
Shape of head	Description	Type of contact		Supply voltage V	Color of push	Reference	Weight kg/lb								
															
		N/O	N/C												
Complete units - With plain lens															
 523844 XB5AW3465	Direct supply for bulb with BA 9s base fitting, 2.4 W max, (bulb not included)	1	1	≤ 250	White	XB5AW3165 (ZB5AW065 + ZB5AW31)	0.057/0.126								
					Green	XB5AW3365 (ZB5AW065 + ZB5AW33)	0.057/0.126								
					Red	XB5AW3465 (ZB5AW065 + ZB5AW34)	0.057/0.126								
					Orange	XB5AW3565 (ZB5AW065 + ZB5AW35)	0.057/0.126								
 963461 XB5AW3335	Via integral transformer 1.2 VA, 6 V secondary, incandescent bulb with BA 9s base fitting, (bulb included)	1	1	~ 110...120 50/60 Hz	White	XB5AW3135 (ZB5AW035 + ZB5AW31)	0.128/0.282								
					Green	XB5AW3335 (ZB5AW035 + ZB5AW33)	0.128/0.282								
					Red	XB5AW3435 (ZB5AW035 + ZB5AW34)	0.128/0.282								
					Orange	XB5AW3535 (ZB5AW035 + ZB5AW35)	0.128/0.282								
								~ 230 50 Hz ~ 220...240 60 Hz	White	XB5AW3145 (ZB5AW045 + ZB5AW31)	0.129/0.284				
									Green	XB5AW3345 (ZB5AW045 + ZB5AW33)	0.129/0.284				
									Red	XB5AW3445 (ZB5AW045 + ZB5AW34)	0.129/0.284				
									Orange	XB5AW3545 (ZB5AW045 + ZB5AW35)	0.129/0.284				
								Heads only ⁽²⁾ - With plain lens							
								 814559 ZB5AW33	Flush				White	ZB5AW31	0.018/0.040
													Green	ZB5AW33	0.018/0.040
													Red	ZB5AW34	0.018/0.040
			Orange	ZB5AW35	0.018/0.040										
			Blue	ZB5AW36	0.018/0.040										
			Clear	ZB5AW37	0.018/0.040										
Heads only ⁽²⁾ - With grooved lens ⁽³⁾															
	Flush				White	ZB5AW31S	0.018/0.040								
					Green	ZB5AW33S	0.018/0.040								
					Red	ZB5AW34S	0.018/0.040								
					Orange	ZB5AW35S	0.018/0.040								
					Blue	ZB5AW36S	0.018/0.040								
					Clear	ZB5AW37S	0.018/0.040								
Illuminated pushbuttons with projecting push ⁽¹⁾															
Heads only ⁽²⁾ - With plain lens															
	Projecting				White	ZB5AW11	0.017/0.037								
					Green	ZB5AW13	0.017/0.037								
					Red	ZB5AW14	0.017/0.037								
					Orange	ZB5AW15	0.017/0.037								
					Blue	ZB5AW16	0.017/0.037								
					Clear	ZB5AW17	0.017/0.037								
Heads only ⁽²⁾ - With grooved lens ⁽³⁾															
	Projecting				White	ZB5AW11S	0.018/0.040								
					Green	ZB5AW13S	0.018/0.040								
					Red	ZB5AW14S	0.018/0.040								
					Orange	ZB5AW15S	0.018/0.040								
					Blue	ZB5AW16S	0.018/0.040								
					Clear	ZB5AW17S	0.018/0.040								

(1) Recommended maximum number of contacts constituting the body (fixing collar and contact) associated with the head, see page 12.

(2) Only for use with bodies comprising a light source with BA9s base fitting bulb (incandescent, neon or LED).

(3) For use in bright ambient light conditions (for example, outdoors in sunlight).

User assembly of other units, using:
body-contacts assemblies: see page 40 combined
sub-assemblies: see page 46



Double-headed pushbuttons (1)						
Screw clamp terminal connections (Schneider Electric anti-loosening system)						
Shape of head	Description	Type of contact		Color and marking of caps (2)	Reference	Weight kg/lb
		N/O	N/C			

Complete units						
	2 pushes (1 flush Black + 1 projecting Red)	1	1	White "I" on Green background White "0" on Red background	XB5AL73415	0.053/0.117

Heads only						
	2 flush Black pushes			White background + Black background, unmarked	ZB5AA7120	0.023/0.051
				Black "I" on White background White "0" on Black background	ZB5AA7121	0.023/0.051
				Green background + Red background, unmarked	ZB5AA7340	0.023/0.051
				White "I" on Green background White "0" on Red background	ZB5AA7341	0.023/0.051
				Without cap (3)	ZB5AA79	0.023/0.051

	1 flush Black push 1 projecting Red push			Green background + Red background, unmarked	ZB5AL7340	0.023/0.051
				White "I" on Green background White "0" on Red background	ZB5AL7341	0.023/0.051

Double-headed pushbuttons + 1 white central pilot light block (1)							
Screw clamp terminal connections (Schneider Electric anti-loosening system)							
Shape of head	Description	Type of contact		Color and marking of caps (2)	Pilot light voltage V	Reference	Weight kg/lb
		N/O	N/C				

Complete units							
	1 flush Black push 1 projecting Red push 1 White central pilot light block	1	1	White "I" on Green background	24	XB5AW73731B5	0.066/0.146
				White "0" on Red background	120	XB5AW73731G5	0.066/0.146
					240	XB5AW73731M5	0.066/0.146

Heads only (5)							
	2 flush Black pushes 1 clear central pilot light (4)			White background + Black background, unmarked		ZB5AW7A1720	0.023/0.051
				Black "I" on White background White "0" on Black background		ZB5AW7A1721	0.023/0.051
				Green background + Red background, unmarked		ZB5AW7A3740	0.023/0.051
				White "I" on Green background White "0" on Red background		ZB5AW7A3741	0.023/0.051
				Black "†" on White background White "‡" on Black background		ZB5AW7A1724	0.023/0.051
				Black "+" on White background Black "-" on White background		ZB5AW7A1715	0.023/0.051
				Without cap (3)		ZB5AW7A9	0.023/0.051

	1 flush Black push 1 projecting Red push 1 clear central pilot light (4)			Green background + Red background, unmarked		ZB5AW7L3740	0.023/0.051
				White "I" on Green background White "0" on Red background		ZB5AW7L3741	0.023/0.051

(1) Recommended maximum number of contacts constituting the body (fixing collar and contact) associated with the head, see page 12.

(2) These caps are fitted by Schneider Electric and cannot be removed (risk of damage).

(3) Caps to be ordered separately: see page opposite.

(4) Color of centrally positioned pilot light determined by the color of the LED incorporated in the body sub-assembly.

(5) Only for use with bodies comprising a light source with integral LED.

User assembly of other units, using:
body-contacts assemblies: see page 40 combined
sub-assemblies: see page 46

Triple-headed pushbuttons (1) (2)							
Screw clamp terminal connections (Schneider Electric anti-loosening system)							
Shape of head	Description	Type of contact			Color and marking of caps (3)	Reference	Weight kg/lb
		N/O	N/C	N/O			

Complete units							
	2 flush Black pushes + 1 central projecting Red push marked "Stop" in White	1	1	1	White "I" on Green background White "II" on Green background	XB5AA731327	0.063/0.139
					Black "→" on White background White "←" on Black background	XB5AA711237	0.063/0.139

Heads only							
	2 flush Black pushes + 1 central projecting Red push marked "Stop" in White				White "I" on Green background White "II" on Green background	ZB5AA73132	0.023/0.051
					White "←" on Green background White "→" on Green background	ZB5AA73133	0.023/0.051
					White "↑" on Green background White "↓" on Green background	ZB5AA73134	0.023/0.051
					White "+" on Green background White "-" on Green background	ZB5AA73135	0.023/0.051
					Black "+" on White background Black "-" on White background	ZB5AA71115	0.023/0.051
					Black "→" on White background White "←" on Black background	ZB5AA71123	0.023/0.051
					Black "↑" on White background White "↓" on Black background	ZB5AA71124	0.023/0.051
					White "↑" on Black background White "↓" on Black background	ZB5AA72124	0.023/0.051
					Without cap (4)	ZB5AA791	0.023/0.051

Specific accessories for multiple-headed pushbuttons						
Description	Background color	Marking	Sold in lots of	Reference	Weight kg/lb	
Caps only for clip-on mounting (5) on: - ZB5AA79 double-headed pushbuttons - ZB5AW7A9 double-headed pushbuttons + central pilot light block - ZB5AA791 triple-headed pushbuttons	White	Unmarked	10	ZBA71	0.010/0.022	
		"I" Black	10	ZBA7131	0.010/0.022	
		"↑" Black	10	ZBA7134	0.010/0.022	
		"+" Black	10	ZBA7138	0.010/0.022	
	Black	Unmarked	10	ZBA72	0.010/0.022	
		"O" White	10	ZBA7232	0.010/0.022	
		"+" White	10	ZBA7233	0.010/0.022	
		"↓" White	10	ZBA7235	0.010/0.022	
		"I" White	10	ZBA7237	0.010/0.022	
	Green	Unmarked	10	ZBA73	0.010/0.022	
		"I" White	10	ZBA7331	0.010/0.022	
		"+" White	10	ZBA7333	0.010/0.022	
		"↑" White	10	ZBA7335	0.010/0.022	
		"II" White	10	ZBA7336	0.010/0.022	
	Red	Unmarked	10	ZBA74	0.010/0.022	
		"O" White	10	ZBA7432	0.010/0.022	
	Yellow	Unmarked	10	ZBA75	0.010/0.022	
	Blue	Unmarked	10	ZBA76	0.010/0.022	
Clear silicone boots (6)	For 2 flush pushes	–	10	ZBA708	0.055/0.121	
	For 3 pushes	–	10	ZBA709	0.055/0.121	
	For 1 flush push + 1 projecting push	–	10	ZBA710	0.055/0.121	

(1) Recommended maximum number of contacts constituting the body (fixing collar and contact) associated with the head, see page 12.

(2) Not compatible with high power switching contacts and contacts for printed circuit board.

(3) These caps are fitted by Schneider Electric and cannot be removed (risk of damage).

(4) Caps to be ordered separately: see accessories on this page.

(5) Can be clipped-in at 90° steps, through 360°.

(6) Can be replaced without dismantling the head.



XB5AA731327



ZB5AA73133



ZB5AA71124



ZBA7235



ZBA7331



ZBA7432









ZBA709

Assembly of other products using:
body/contact assemblies: see page 40
accessories: see page 52

Control and signaling units Ø 22

Harmony® XB5, plastic

Mushroom head pushbuttons, spring return

Mushroom head pushbuttons (1) (2)							
Screw clamp terminal connections (Schneider Electric anti-loosening system)							
Shape of head	Type of push	Type of contact		Push Ø (mm)/in.	Color	Reference	Weight kg/lb
							
		N/O	N/C				
Complete units							
	Mushroom head	1	-	40/1.575	Black	ZB5AC21	0.062/0.137
						(ZB5AZ101 + ZB5AC2)	
Heads only							
	Mushroom head			30/1.181	Black	ZB5AC24	0.027/0.060
					Green	ZB5AC34	0.027/0.060
					Red	ZB5AC44	0.027/0.060
					Yellow	ZB5AC54	0.027/0.060
					Blue	ZB5AC64	0.027/0.060
				40/1.575	Black	ZB5AC2	0.046/0.101
					Green	ZB5AC3	0.046/0.101
					Red	ZB5AC4	0.046/0.101
					Yellow	ZB5AC5	0.046/0.101
					Blue	ZB5AC6	0.046/0.101
				60/2.362	Black	ZB5AR2	0.065/0.143
					Green	ZB5AR3	0.065/0.143
					Red	ZB5AR4	0.065/0.143
					Yellow	ZB5AR5	0.065/0.143
					Blue	ZB5AR6	0.065/0.143
				60/2.362 (3) Hemispherical	Black	ZB5AR216	0.048/0.106
					Green	ZB5AR316	0.048/0.106
					Red	ZB5AR416	0.048/0.106
					Yellow	ZB5AR516	0.048/0.106
					Blue	ZB5AR616	0.048/0.106



XB5AC21



ZB5AC24



ZB5AC2



ZB5AR4





ZB5AR216

- (1) These pushbuttons and heads cannot be used for an Emergency Stop function. Therefore, it is recommended that a legend with a Black or White background is used.
- (2) Recommended maximum number of contacts constituting the body (fixing collar and contact) associated with the head, see page 12.
- (3) Ergonomic product used in two-handed control applications. Recommended maximum number of contacts constituting the body (fixing collar and contact) associated with the head: 6.

Assembly of other products using:
body/contact assemblies: see page 40
accessories: see page 52

Control and signaling units Ø 22 Harmony® XB5, plastic Mushroom head pushbuttons, latching

Mushroom head pushbuttons (1) (2)

Shape of head	Type of reset	Push Ø (mm)/in.	Color	Reference	Weight kg/lb
Heads only					
	Push-pull	30/1.181	Black	ZB5AT24	0.044/0.097
		40/1.575	Black	ZB5AT2	0.049/0.108
		60/2.362	Black	ZB5AX2	0.067/0.148
	Turn to release	30/1.181	Black	ZB5AS42	0.040/0.088
		40/1.575	Black	ZB5AS52	0.044/0.097
		40/1.575	Yellow	ZB5AS55	0.044/0.097
		60/2.362	Black	ZB5AS62	0.064/0.141
	Key release (key n° 455) (2 keys included with head) (3) (5)	30/1.181	Black	ZB5AS72	0.040/0.088
		40/1.575	Black	ZB5AS12 (4)	0.044/0.097
		60/2.362	Black	ZB5AS22	0.064/0.141



ZB5AT2



ZB5AS62



ZB5AS72

Illuminated mushroom head pushbuttons (2)

Shape of head	Type of reset	Push Ø (mm)/in.	Color	Reference	Weight kg/lb
Heads only (6)					
	Turn to release	40/1.575	White	ZB5AW713	0.022/0.049
			Green	ZB5AW733	0.022/0.049
			Orange	ZB5AW753	0.022/0.049
			Blue	ZB5AW763	0.022/0.049



ZB5AW733

(1) These pushbuttons and heads cannot be used for an Emergency Stop function.

Therefore, it is recommended that a legend with a Black or White background is used.

(2) Recommended maximum number of contacts constituting the body (fixing collar and contact) associated with the head, see page 12.

(3) For specific keys with other numbers, please consult our Customer Care Centre.

(4) Other key numbers:

- key n° 421E: add suffix 12 to the reference.

- key n° 458A: add suffix 10 to the reference.

- key n° 520E: add suffix 14 to the reference.

- key n° 3131A: add suffix 20 to the reference.

Example: To order a Ø 40mm/1.575 in. Black mushroom head for a latching pushbutton, with release by key n° 421E, the reference becomes:

ZB5AS1212.

(5) The symbol  indicates key withdrawal position(s).

(6) Only for use with bodies comprising a light source with integral LED.

Assembly of other products using:
 body/contact assemblies: see page 40
 combined sub-assemblies: see page 46
 accessories: see pages 61 and 62

Control and signaling units Ø 22

Harmony® XB5, plastic

Emergency stop and Emergency switching off functions

Conforming to EN/IEC 60204-1, 60364-5-53,
 EN/ISO 13850 and Machinery Directive 2006/42/EC



Emergency stop function: Mushroom head Emergency stop trigger action and mechanical latching pushbuttons conform to standards EN/IEC 60204-1 and EN/ISO 13850, to Machinery Directive 2006/42/EC and to standard EN/IEC 60947-5-5.

Emergency switching off function: Mushroom head switching off mechanical latching pushbuttons conform to standards IEC 60364-5-53 and EN/IEC 60947-5-5.



Please consult our Customer Care Centre for a full explanation of these standards and directives.

Emergency stop and switching off pushbuttons with trigger action and mechanical latching (1) (2)



Screw clamp terminal connections (Schneider Electric anti-loosening system)

Shape of head	Type of reset	Type of contact	Push Ø (mm)/in.	Color	Reference	Weight kg/lb
		 N/O				
		 N/C				

Complete units

	Push-pull	–	1	40/1.575	Red	XB5AT842 (ZB5AZ102 + ZB5AT84)	0.065/0.143
		1	1	40/1.575	Red	XB5AT845 (ZB5AZ105 + ZB5AT84)	0.076/0.168
	Turn to release	–	1	40/1.575	Red	XB5AS8442 (ZB5AZ102 + ZB5AS844)	0.060/0.132
		1	1	40/1.575	Red	XB5AS8445 (ZB5AZ105 + ZB5AS844)	0.072/0.159
		–	2	40/1.575	Red	XB5AS8444 (ZB5AZ104 + ZB5AS844)	0.072/0.159
	Key release (key n° 455)(3)	–	1	40/1.575	Red	XB5AS9442 (ZB5AZ102 + ZB5AS944)	0.075/0.165
		1	1	40/1.575	Red	XB5AS9445 (ZB5AZ105 + ZB5AS944)	0.112/0.247

Heads only

	Push-pull			30/1.181	Red	ZB5AT844	0.049/0.108
				40/1.575	Red	ZB5AT84	0.049/0.108
				60/2.362	Red	ZB5AX84	0.067/0.148
	Turn to release			30/1.181	Red	ZB5AS834	0.042/0.092
				40/1.575	Red	ZB5AS844	0.046/0.102
	Key release (key n° 455) (2 keys included with head) (5)(3)			30/1.181	Red	ZB5AS934	0.068/0.150
				40/1.575	Red	ZB5AS944 (4)	0.071/0.157
				60/2.362	Red	ZB5AS964	0.092/0.204
				40/1.575	Red	ZB5AS944D	0.071/0.157

Illuminated Emergency stop and Emergency switching off functions (mechanical latching pushbuttons with mechanical state indicator (1))

For elevator inspection box applications

Heads only (6)

Shape of head	Type of reset	Push Ø (mm)/in.	Color	Unit reference	Weight kg/lb
	Push-pull (7) For Emergency stop and Emergency switching off function	40/1.575	Red	ZB5AT8643M	0.034/0.075

Illuminated Emergency switching off function only, mechanical latching pushbuttons (1)

Screw clamp terminal connections (Schneider Electric anti-loosening system)

Shape of head	Type of reset	Push Ø (mm)/in.	Color	Reference	Weight kg/lb
	Turn to release	40/1.575	Red	ZB5AW743	0.022/0.049

(1) Recommended maximum number of contacts constituting the body (fixing collar and contact) associated with the head, see page 12.

(2) It is recommended that a legend or Yellow background is used.

(3) The symbol  indicates key withdrawal position(s).

(4) Other key numbers:

- key n° 421E: add suffix **12** to the reference.
- key n° 458A: add suffix **10** to the reference.
- key n° 520E: add suffix **14** to the reference.
- key n° 3131A: add suffix **20** to the reference.
- key n° 4A185: add suffix **D** to the reference.

Example: To order a Ø 40 mm/1.575 in. Red mushroom head for a trigger action and mechanical latching Emergency stop pushbutton, with release by key n° 421E, the reference becomes: **ZB5AS94412**.

(5) For specific keys with other numbers, please consult our Customer Care Centre.

(6) Only for use with bodies comprising a light source with integral LED.

(7) Cannot be used with metal guards **ZBZ160**.

References

Assembly of other products using:
body/contact assemblies: see page 40
combined sub-assemblies: see page 46
accessories: see pages 61 and 62

Control and signaling units Ø 22

Harmony® XB5, plastic

General safe stop

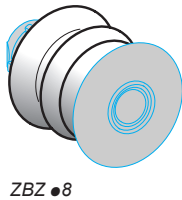

General safe stops

General safe stops are used to stop the operation of a machine in a safe manner. These devices cannot be used as Emergency stop and must not be associated with a Yellow background. The general safe stop are made with Yellow bezel and Black head.

Shape of head	Type of reset	Push		Reference	Weight kg/lb
		Ø (mm)/in.	Color		
	Push-pull	40/1.575	Black	ZB5AT82Y	0.050/0.110
	Turn to release	40/1.575	Black	ZB5AS842Y	0.046/0.101
	Key release (key n° 455) 2 keys included with head (2)	40/1.575	Black	ZB5AS942Y	0.071/0.157

Circular yellow legends for Emergency stop (1)

Description	Marking	Color	Sold in lots of	Reference	Weight kg/lb
Ø 60 mm /2.362 in. legend for Emergency stop function	-	Yellow	5	ZBY9121	0.007/0.015
	EMERGENCY STOP	Yellow	5	ZBY9320	0.007/0.015
	ARRET D'URGENCE	Yellow	5	ZBY9120	0.007/0.015
	NOT HALT	Yellow	5	ZBY9220	0.007/0.015
	PARADA DE EMERGENCIA	Yellow	5	ZBY9420	0.007/0.015
	ARRESTO DI EMERGENZA	Yellow	5	ZBY9620	0.007/0.015

Bellows for harsh environments (IP 69K) (3)

Description	Material	For use with	Color	Sold in lots of	Unit reference	Weight kg/lb
For use in environments subject to humidity, dust, high pressure cleaning, etc.	Silicone	Emergency stop / Switching off function	Yellow	2	ZBZ28	0.009/0.020
		Other functions	Black	2	ZBZ58	0.009/0.020

(1) Other legend models for Emergency stop and Emergency switching off function, see page 58 of catalog DIA5D21212EN

(2) The symbol indicates key withdrawal position(s).

(3) Not compatible with Ø 30 mm/1.181 in. pushbuttons.

Assembly of other products using:
 body/contact assemblies: see page 40
 combined sub-assemblies: see page 46
 accessories: see page 52



ZB5AH04

Pushbuttons with flush push (1)

Shape of head	Type of push	Color of push	Reference	Weight kg/lb
Heads only, circular				
	Without cap (2)	–	ZB5AH0	0.018/0.040
	Flush	White	ZB5AH01	0.018/0.040
		Black	ZB5AH02	0.018/0.040
		Green	ZB5AH03	0.018/0.040
		Red	ZB5AH04	0.018/0.040
		Yellow	ZB5AH05	0.018/0.040
		Blue	ZB5AH06	0.018/0.040
Heads only, square				
	Without cap (2)	–	ZB5CH0	0.020/0.044
	Flush	White	ZB5CH01	0.020/0.044
		Black	ZB5CH02	0.020/0.044
		Green	ZB5CH03	0.020/0.044
		Red	ZB5CH04	0.020/0.044
		Yellow	ZB5CH05	0.020/0.044
		Blue	ZB5CH06	0.020/0.044

Pushbuttons with projecting push (1)

Shape of head	Type of push	Color of push	Reference	Weight kg/lb
Heads only, circular				
	Projecting	White	ZB5AH1	0.018/0.040
		Black	ZB5AH2	0.018/0.040
		Green	ZB5AH3	0.018/0.040
		Red	ZB5AH4	0.018/0.040
		Yellow	ZB5AH5	0.018/0.040
		Blue	ZB5AH6	0.018/0.040

Illuminated pushbuttons with flush push (1)

Shape of head	Type of push	Color of push	Reference	Weight kg/lb
Heads only, circular (3)				
	Flush	White	ZB5AH013	0.017/0.037
		Green	ZB5AH033	0.017/0.037
		Red	ZB5AH043	0.017/0.037
		Orange	ZB5AH053	0.017/0.037
		Blue	ZB5AH063	0.017/0.037
Heads only, square (3)				
	Flush	White	ZB5CH313	0.018/0.040
		Green	ZB5CH333	0.018/0.040
		Red	ZB5CH343	0.018/0.040
		Orange	ZB5CH353	0.018/0.040
		Blue	ZB5CH363	0.018/0.040



ZB5CH343

Illuminated pushbuttons with projecting push (1)

Shape of head	Type of push	Color of push	Reference	Weight kg/lb
Heads only, circular (3)				
	Projecting	White	ZB5AH13	0.017/0.037
		Green	ZB5AH33	0.017/0.037
		Red	ZB5AH43	0.017/0.037
		Orange	ZB5AH53	0.017/0.037
		Blue	ZB5AH63	0.017/0.037

(1) Recommended maximum number of contacts constituting the body (fixing collar and contact) associated with the head, see page 12.

(2) Caps to be ordered separately, see page 52.

(3) Only for use with bodies comprising a light source with integral LED.

Assembly of other products using:
body/contact assemblies: see page 40
accessories: see page 52

Control and signaling units Ø 22

Harmony® XB5, plastic

Pushbuttons, "push-turn to release"

523836



ZB5AFDA

Pushbuttons with key-operated push (1)

Shape of head	Type of push	Locking	Key withdrawal	Reference	Weight kg/lb
Heads only					
	Key n° 4A185	Both positions	Both positions	ZB5AFDA	0.050/0.110
		Actuated position	Actuated position	ZB5AFDB	0.050/0.110
		Rest position	Rest position	ZB5AFDC	0.050/0.110
		Actuated position	Both positions	ZB5AFDD	0.050/0.110
	Key LU1	Both positions	Both positions	ZB5AFDE01	0.050/0.110
	Key LU2	Both positions	Both positions	ZB5AFDE02	0.050/0.110
	Key LU3	Both positions	Both positions	ZB5AFDE03	0.050/0.110
	Key LU4	Both positions	Both positions	ZB5AFDE04	0.050/0.110
	Key LU5	Both positions	Both positions	ZB5AFDE05	0.050/0.110
	Key LU6	Both positions	Both positions	ZB5AFDE06	0.050/0.110
	Key LU7	Both positions	Both positions	ZB5AFDE07	0.050/0.110
	Key LU8	Both positions	Both positions	ZB5AFDE08	0.050/0.110
	Key LU9	Both positions	Both positions	ZB5AFDE09	0.050/0.110
	Key LU10	Both positions	Both positions	ZB5AFDE10	0.050/0.110
	Key LU11	Both positions	Both positions	ZB5AFDE11	0.050/0.110
	Key LU12	Both positions	Both positions	ZB5AFDE12	0.050/0.110
	Key LU13	Both positions	Both positions	ZB5AFDE13	0.050/0.110
	Key LU14	Both positions	Both positions	ZB5AFDE14	0.050/0.110
	Key LU15	Both positions	Both positions	ZB5AFDE15	0.050/0.110

110321



ZB5AF

110322



ZB5AF351

Pushbuttons with knurled push (1)

Shape of head	Type of push	Marking	Reference	Weight kg/lb
Heads only				
	Knurled without cap (2)	–	ZB5AF	0.027/0.060
		↑ (White on Black background)	ZB5AF351	0.030/0.066

(1) Recommended maximum number of contacts constituting the body (fixing collar and contact) associated with the head, see page 12.

(2) Colored caps to be ordered separately: see page 52.







Assembly of other products using:
body/contact assemblies: see page 40
accessories: see page 52







Control and signaling units Ø 22

Harmony® XB5, plastic

Selector switches with standard handle

Selector switches with standard handle ⁽¹⁾							
Screw clamp terminal connections (Schneider Electric anti-loosening system)							
Shape of head	Type of operator	Type of contact		Positions		Reference	Weight kg/lb
		N/O	N/C	Number	Type		

Complete units								
	Standard handle, black	1	–	2-position 90°	Stay put		XB5AD21 (ZB5AZ101 + ZB5AD2)	0.043/0.095
		1	–		Spring return from right to left		XB5AD41 (ZB5AZ101 + ZB5AD4)	0.046/0.101
		1	1		Stay put		XB5AD25 (ZB5AZ105 + ZB5AD2)	0.043/0.095
		2	–	3-position ± 45°	Stay put		XB5AD33 (ZB5AZ103 + ZB5AD3)	0.043/0.095
					Spring return to centre		XB5AD53 (ZB5AZ103 + ZB5AD5)	0.043/0.095

Heads only								
	Standard handle, black			2-position 90°	Stay put		ZB5AD2	0.017/0.037
					Spring return from right to left		ZB5AD4	0.020/0.044
				3-position ± 45°	Stay put		ZB5AD3	0.017/0.037
					Spring return to centre		ZB5AD5	0.017/0.037
					Spring return from left to centre		ZB5AD7	0.017/0.037
					Spring return from right to centre		ZB5AD8	0.017/0.037

Heads only with other colored handles		
	Standard handle, White	add suffix 01 to the reference, example: ZB5AD201
	Standard handle, Green	add suffix 03 to the reference, example: ZB5AD203
	Standard handle, Red	add suffix 04 to the reference, example: ZB5AD204
	Standard handle, Yellow	add suffix 05 to the reference, example: ZB5AD205
	Standard handle, Blue	add suffix 06 to the reference, example: ZB5AD206









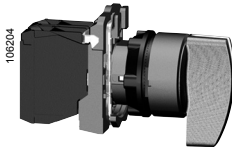

(1) Recommended maximum number of contacts and sequence of contacts constituting the body (fixing collar and contact) associated with the head, see page 12.

Assembly of other products using:
body/contact assemblies: see page 40
accessories: see page 52

Control and signaling units Ø 22

























Harmony® XB5, plastic

Selector switches with long handle

Selector switches with long handle ⁽¹⁾							
Screw clamp terminal connections (Schneider Electric anti-loosening system)							
Shape of head	Type of operator	Type of contact		Positions		Reference	Weight kg/lb
		N/O	N/C	Number	Type		
Complete units							
	Long handle, black	1	-	2-position 90°	Stay put	 ZB5AJ21 (ZB5AZ101 + ZB5AJ2)	0.043/0.095
				3-position ± 45°	Stay put	 ZB5AJ33 (ZB5AZ103 + ZB5AJ3)	0.043/0.095
					Spring return to centre	 ZB5AJ53 (ZB5AZ103 + ZB5AJ5)	0.043/0.095
Heads only							
	Long handle, black	1	-	2-position 90°	Stay put	 ZB5AJ2	0.017/0.037
					Spring return from right to left	 ZB5AJ4	0.020/0.044
				3-position ± 45°	Stay put	 ZB5AJ3	0.017/0.037
					Spring return to centre	 ZB5AJ5	0.017/0.037
					Spring return from left to centre	 ZB5AJ7	0.017/0.037
					Spring return from right to centre	 ZB5AJ8	0.017/0.037

(1) Recommended maximum number of contacts and sequence of contacts constituting the body (fixing collar and contact) associated with the head, see page 12.

Assembly of other products using:
body/contact assemblies: see page 40
accessories: see page 52

Key switches (1)										
Screw clamp terminal connections (Schneider Electric anti-loosening system)										
Shape of head	Type of operator	Type of contact		Positions		Reference	Weight kg/lb			
				Number	Type (2)					
Complete units										
 XB5AG3		Key switch with key n° 455	1	-	2-position 90°	Stay put	 XB5AG21 (ZB5AZ101 + ZB5AG2)	0.831/1.832		
							 XB5AG41 (ZB5AZ101 + ZB5AG4)	0.831/1.832		
					Spring return to left	 XB5AG61 (ZB5AZ101 + ZB5AG6)	0.870/1.918			
			2	-	3-position ± 45°	Stay put	 XB5AG03 (ZB5AZ103 + ZB5AG0)	0.831/1.832		
	 XB5AG33 (ZB5AZ103 + ZB5AG3)	0.831/1.832								
Heads only										
 ZB5AG2		Key switch with key n° 455 (3) (4)			2-position 90°	Stay put	 ZB5AG2	0.057/0.126		
							 ZB5AG02	0.057/0.126		
							 ZB5AG4	0.057/0.126		
							Spring return from right to left	 ZB5AG6	0.061/0.134	
						3-position ± 45°	Stay put	 ZB5AG0	0.057/0.126	
								 ZB5AG3	0.057/0.126	
								 ZB5AG5	0.057/0.126	
								 ZB5AG9	0.057/0.126	
								 ZB5AG09	0.057/0.126	
								Spring return from left to centre	 ZB5AG1	0.057/0.126
								Spring return to centre	 ZB5AG7	0.057/0.126
								Spring return from right to centre	 ZB5AG8	0.057/0.126
	 ZB5AG05	0.057/0.126								
	 ZB5AG08	0.057/0.126								

(1) Recommended maximum number of contacts and sequence of contacts constituting the body (fixing collar and contact) associated with the head, see page 12.

(2) The symbol  indicates key withdrawal position(s).

(3) Other key numbers:

- key n° 421E: add suffix **12** to the reference.

- key n° 458A: add suffix **10** to the reference.

- key n° 520E: add suffix **14** to the reference.

- key n° 3131A: add suffix **20** to the reference.

Example: For a switch head with key n° 421E, 2-position stay put with key withdrawal from the left-hand position, the reference becomes: **ZB5AG212**.

(4) For specific keys with other numbers, please consult our Customer Care Centre.

Assembly of other products using:
body/contact assemblies: see page 40
accessories: see page 52





















Control and signaling units Ø 22

Harmony® XB5, plastic







Key switches with key 8D1

Selector switches with knurled knob - Toggle switches

Key switches (continued) (1) Screw clamp terminal connections (Schneider Electric anti-loosening system)

Shape of head	Type of operator	Positions (2)		Reference	Weight kg/lb				
		Number	Type						
	Key switch with key n° 8D1	2-position 90°	Stay put		ZB5AG2D	0.057/0.126			
					ZB5AG02D	0.057/0.126			
					ZB5AG4D	0.057/0.126			
			Spring return from right to left		ZB5AG6D	0.061/0.134			
		3-position ± 45°	Stay put				ZB5AG0D	0.057/0.126	
							ZB5AG3D	0.057/0.126	
							ZB5AG5D	0.057/0.126	
							ZB5AG9D	0.057/0.126	
							ZB5AG09D	0.057/0.126	
							ZB5AG03D	0.057/0.126	
							ZB5AG04D	0.057/0.126	
						Spring return from left to centre		ZB5AG06D	0.057/0.126
								ZB5AG1D	0.057/0.126
								ZB5AG07D	0.057/0.126
		Spring return from right to centre					ZB5AG8D	0.057/0.126	
							ZB5AG08D	0.057/0.126	
					ZB5AG05D	0.057/0.126			
					ZB5AG7D	0.057/0.126			
	Spring return to centre								







Selector switches with knurled knob (1)

Shape of head	Type of operator	Positions		Reference	Weight kg/lb				
		Number	Type						
Heads only									
	Black knurled knob	2-position 90°	Stay put		ZB5AD29	0.020/0.044			
				Spring return from right to left		ZB5AD49	0.024/0.053		
		3-position ± 45°	Stay put				ZB5AD39	0.020/0.044	
						Spring return to centre		ZB5AD59	0.020/0.044
						Spring return from left to centre		ZB5AD79	0.020/0.044
						Spring return from right to centre		ZB5AD89	0.020/0.044



ZB5AD39

Toggle switches (1)

Shape of head	Type of operator	Positions		Reference	Weight kg/lb	
		Number	Type			
Heads only						
	Black lever	2-position 90°	Stay put		ZB5AD28	0.023/0.051
				Spring return		ZB5AD48
	White lever	2-position 90°	Stay put		ZB5AD2801	0.023/0.051
	Red lever	2-position 90°	Stay put		ZB5AD2804	0.023/0.051
	Blue lever	2-position 90°	Stay put		ZB5AD2806	0.023/0.051



ZB5AD28

(1) Recommended maximum number of contacts and sequence of contacts constituting the body (fixing collar and contact) associated with the head, see page 12.





(2) The symbol  indicates key withdrawal position(s)

Assembly of other products using:
combined sub-assemblies: see page 46
accessories: see page 52

Control and signaling units Ø 22

Harmony® XB5, plastic

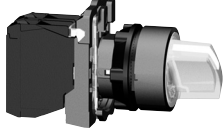
Illuminated selector switches with standard handle,
with integral LED

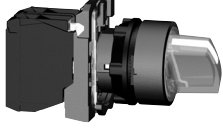
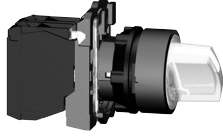
Illuminated selector switches with standard handle, with integral LED ⁽¹⁾																
Screw clamp terminal connections (Schneider Electric anti-loosening system)																
Shape of head	Type of operator	Type of contact		Positions Number Type	Supply voltage V	Color of handle	Reference	Weight kg/lb								
																
		N/O	N/C													
Complete units																
 XB5AK123•5		Standard handle	1	1	2-position Stay put 90°	≈ 24 (50/60 Hz)	Green	XB5AK123B5 (ZB5AW0B35 + ZB5AK1233)	0.516/1.138							
							Red	XB5AK124B5 (ZB5AW0B45 + ZB5AK1243)	0.516/1.138							
							Orange	XB5AK125B5 (ZB5AW0B55 + ZB5AK1253)	0.516/1.138							
							Green	XB5AK123G5 (ZB5AW0G35 + ZB5AK1233)	0.516/1.138							
							Red	XB5AK124G5 (ZB5AW0G45 + ZB5AK1243)	0.516/1.138							
							Orange	XB5AK125G5 (ZB5AW0G55 + ZB5AK1253)	0.516/1.138							
							Green	XB5AK123M5 (ZB5AW0M35 + ZB5AK1233)	0.516/1.138							
							Red	XB5AK124M5 (ZB5AW0M45 + ZB5AK1243)	0.516/1.138							
							Orange	XB5AK125M5 (ZB5AW0M55 + ZB5AK1253)	0.516/1.138							
							 XB5AK124•5			1	1	3-position Stay put ± 45°	≈ 24 (50/60 Hz)	Green	XB5AK133B5 (ZB5AW0B35 + ZB5AK1333)	0.516/1.138
														Red	XB5AK134B5 (ZB5AW0B45 + ZB5AK1343)	0.516/1.138
														Orange	XB5AK135B5 (ZB5AW0B55 + ZB5AK1353)	0.516/1.138
Green	XB5AK133G5 (ZB5AW0G35 + ZB5AK1333)	0.516/1.138														
Red	XB5AK134G5 (ZB5AW0G45 + ZB5AK1343)	0.516/1.138														
Orange	XB5AK135G5 (ZB5AW0G55 + ZB5AK1353)	0.516/1.138														
Green	XB5AK133M5 (ZB5AW0M35 + ZB5AK1333)	0.516/1.138														
Red	XB5AK134M5 (ZB5AW0M45 + ZB5AK1343)	0.516/1.138														
Orange	XB5AK135M5 (ZB5AW0M55 + ZB5AK1353)	0.516/1.138														
 XB5AK125•5			1	1										Green	XB5AK133B5 (ZB5AW0B35 + ZB5AK1333)	0.516/1.138
														Red	XB5AK134B5 (ZB5AW0B45 + ZB5AK1343)	0.516/1.138
														Orange	XB5AK135B5 (ZB5AW0B55 + ZB5AK1353)	0.516/1.138
							Green	XB5AK133G5 (ZB5AW0G35 + ZB5AK1333)	0.516/1.138							
							Red	XB5AK134G5 (ZB5AW0G45 + ZB5AK1343)	0.516/1.138							
							Orange	XB5AK135G5 (ZB5AW0G55 + ZB5AK1353)	0.516/1.138							
							Green	XB5AK133M5 (ZB5AW0M35 + ZB5AK1333)	0.516/1.138							
							Red	XB5AK134M5 (ZB5AW0M45 + ZB5AK1343)	0.516/1.138							
							Orange	XB5AK135M5 (ZB5AW0M55 + ZB5AK1353)	0.516/1.138							











(1) Recommended maximum number of contacts constituting the body (fixing collar and contact) associated with the head, see page 12.

Assembly of other products using:
combined sub-assemblies: see page 46
accessories: see page 52

Control and signaling units Ø 22

Harmony® XB5, plastic

Illuminated selector switches with standard handle,
with integral LED

Illuminated selector switches with standard handle, with integral LED (continued) (1)							
Shape of head	Type of operator	Positions			Color of handle	Reference	Weight kg/lb
		Number	Type				
Heads only (2)							
 108225 ZB5AK1263	 Standard handle	2-position 90°	Stay put		White	ZB5AK1213	0.016/0.035
					Green	ZB5AK1233	0.016/0.035
					Red	ZB5AK1243	0.016/0.035
					Orange	ZB5AK1253	0.016/0.035
					Blue	ZB5AK1263	0.016/0.035
 108227 ZB5AK1463				Spring return from right to left 	White	ZB5AK1413	0.017/0.037
					Green	ZB5AK1433	0.017/0.037
					Red	ZB5AK1443	0.017/0.037
					Orange	ZB5AK1453	0.017/0.037
					Blue	ZB5AK1463	0.017/0.037
		3-position ± 45°	Stay put		White	ZB5AK1313	0.016/0.035
					Green	ZB5AK1333	0.016/0.035
					Red	ZB5AK1343	0.016/0.035
					Orange	ZB5AK1353	0.016/0.035
					Blue	ZB5AK1363	0.016/0.035
				Spring return to centre 	White	ZB5AK1513	0.016/0.035
					Green	ZB5AK1533	0.016/0.035
					Red	ZB5AK1543	0.016/0.035
					Orange	ZB5AK1553	0.016/0.035
					Blue	ZB5AK1563	0.016/0.035
				Spring return from right to centre 	White	ZB5AK1813	0.016/0.035
					Green	ZB5AK1833	0.016/0.035
					Red	ZB5AK1843	0.016/0.035
					Orange	ZB5AK1853	0.016/0.035
					Blue	ZB5AK1863	0.016/0.035
				Spring return from left to centre 	White	ZB5AK1713	0.016/0.035
					Green	ZB5AK1733	0.016/0.035
					Red	ZB5AK1743	0.016/0.035
					Orange	ZB5AK1753	0.016/0.035
					Blue	ZB5AK1763	0.016/0.035

(1) Recommended maximum number of contacts constituting the body (fixing collar + contact) associated with the head, see page 12.

(2) Only for use with bodies comprising a light source with integral LED.

Assembly of other products using:
light block sub-assemblies: see page 48
accessories: see page 52

Control and signaling units Ø 22

Harmony® XB5, plastic
Pilot lights with integral LED



XB5AVB1



Pilot lights with integral LED						
Screw clamp terminal connections (Schneider Electric anti-loosening system)						
Shape of head	Supply voltage V	Color	Reference for monolithic units	Reference for complete units	Weight kg/lb	
Complete units (With plain lens)						
	~ 24 (50/60 Hz)	White	XB5EVB1	XB5AVB1 (ZB5AVB1 + ZB5AV013)	0.038/0.084	
		Green	XB5EVB3	XB5AVB3 (ZB5AVB3 + ZB5AV033)	0.038/0.084	
		Red	XB5EVB4	XB5AVB4 (ZB5AVB4 + ZB5AV043)	0.038/0.084	
		Orange	XB5EVB5	XB5AVB5 (ZB5AVB5 + ZB5AV053)	0.038/0.084	
		Blue	XB5EVB6	XB5AVB6 (ZB5AVB6 + ZB5AV063)	0.038/0.084	
		Yellow	XB5EVB8	–	0.038/0.084	
		~ 110...120 (50/60 Hz)	White	XB5EVG1	XB5AVG1 (ZB5AVG1 + ZB5AV013)	0.038/0.084
			Green	XB5EVG3	XB5AVG3 (ZB5AVG3 + ZB5AV033)	0.038/0.084
Red	XB5EVG4		XB5AVG4 (ZB5AVG4 + ZB5AV043)	0.038/0.084		
Orange	XB5EVG5		XB5AVG5 (ZB5AVG5 + ZB5AV053)	0.038/0.084		
Blue	XB5EVG6		XB5AVG6 (ZB5AVG6 + ZB5AV063)	0.038/0.084		
Yellow	XB5EVG8		–	0.038/0.084		
~ 230...240 (50/60 Hz)	White		XB5EVM1	XB5AVM1 (ZB5AVM1 + ZB5AV013)	0.038/0.084	
	Green		XB5EVM3	XB5AVM3 (ZB5AVM3 + ZB5AV033)	0.038/0.084	
	Red	XB5EVM4	XB5AVM4 (ZB5AVM4 + ZB5AV043)	0.038/0.084		
	Orange	XB5EVM5	XB5AVM5 (ZB5AVM5 + ZB5AV053)	0.038/0.084		
	Blue	XB5EVM6	XB5AVM6 (ZB5AVM6 + ZB5AV063)	0.038/0.084		
	Yellow	XB5EVM8	–	0.038/0.084		



XB5EV..

Heads only, circular (1)

Shape of head	For use with body comprising light source type	Color of lens	Reference	Weight kg/lb
■ With plain lens				
	Integral LED only Protected LED	White	ZB5AV013	0.017/0.037
		Green	ZB5AV033	0.017/0.037
		Red	ZB5AV043	0.017/0.037
		Orange	ZB5AV053	0.017/0.037
		Blue	ZB5AV063	0.017/0.037
		5 colors (2) (3)	ZB5AV003	0.017/0.037
■ With plain lens, for insertion of legend (3)				
	Integral LED only Protected LED	White	ZB5AV013E	0.017/0.037
		Green	ZB5AV033E	0.017/0.037
		Red	ZB5AV043E	0.017/0.037
		Orange	ZB5AV053E	0.017/0.037
		Blue	ZB5AV063E	0.017/0.037
■ With grooved lens (4)				
	Integral LED only Protected LED	White	ZB5AV013S	0.017/0.037
		Green	ZB5AV033S	0.017/0.037
		Red	ZB5AV043S	0.017/0.037
		Orange	ZB5AV053S	0.017/0.037
		Blue	ZB5AV063S	0.017/0.037



ZB5AV053

Heads only, square (1)

■ With plain lens				
	Integral LED only Protected LED	White	ZB5CV013	0.020/0.044
		Green	ZB5CV033	0.020/0.044
		Red	ZB5CV043	0.020/0.044
		Orange	ZB5CV053	0.020/0.044
		Blue	ZB5CV063	0.020/0.044
		5 colors (2)	ZB5CV003	0.028/0.062



ZB5CV063

(1) Only for use with bodies comprising a light source with integral LED.

(2) Head supplied with 5 different colored lenses (White, Green, Red, Orange, Blue) not fitted, for insertion of legend.

(3) For legend ordering information: see page 61.

(4) For use in bright ambient light conditions (for example, outdoors in sunlight).

Assembly of other products using:
light block sub-assemblies: see page 48
accessories: see page 52

Control and signaling units Ø 22

Harmony® XB5, plastic

Pilot lights with integral LED and with BA 9s base fitting

080703



XB5AV5B

Pilot lights with integral LED and transformer (1.2 VA, 24 V secondary) Screw clamp terminal connections (Schneider Electric anti-loosening system)

Shape of head	Supply voltage V	Color	Reference (1)	Weight kg/lb
Complete units - With plain lens				
	~ 400 - 50 Hz (1)	White	XB5AV5B1	0.133/0.293
		Green	XB5AV5B3	0.133/0.293
		Red	XB5AV5B4	0.133/0.293
		Orange	XB5AV5B5	0.133/0.293
		Blue	XB5AV5B6	0.133/0.293

Protected
LED



PF110403



XB5AV63

Pilot lights with BA 9s base fitting, with plain or grooved lens Screw clamp terminal connections (Schneider Electric anti-loosening system)

Shape of head	Supply voltage V	Color	Reference	Weight kg/lb
Complete units - With plain lens				
■ Direct supply, for BA 9s bulb, U ≤ 250 V, 2.4 W max (bulb not included)				
	≤ 250	White	XB5AV61 (ZB5AV6 + ZB5AV01)	0.037/0.082
		Green	XB5AV63 (ZB5AV6 + ZB5AV03)	0.037/0.082
		Red	XB5AV64 (ZB5AV6 + ZB5AV04)	0.037/0.082
		Orange	XB5AV65 (ZB5AV6 + ZB5AV05)	0.037/0.082

■ Via integral transformer, 1.2 VA, 6 V secondary, with BA 9s incandescent bulb (included)				
	~ 110...120 - 50/60 Hz	White	XB5AV31 (ZB5AV3 + ZB5AV01)	0.109/0.240
		Green	XB5AV33 (ZB5AV3 + ZB5AV03)	0.109/0.240
		Red	XB5AV34 (ZB5AV3 + ZB5AV04)	0.109/0.240
		Orange	XB5AV35 (ZB5AV3 + ZB5AV05)	0.109/0.240
	~ 230 - 50 Hz ~ 220...240 - 60 Hz	White	XB5AV41 (ZB5AV4 + ZB5AV01)	0.110/0.243
		Green	XB5AV43 (ZB5AV4 + ZB5AV03)	0.110/0.243
		Red	XB5AV44 (ZB5AV4 + ZB5AV04)	0.110/0.243
		Orange	XB5AV45 (ZB5AV4 + ZB5AV05)	0.110/0.243

814391

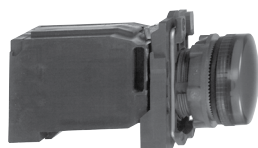

XB5AV34

Heads only (2)

Shape of head	For use with body comprising light source type	Color of lens	Reference	Weight kg/lb
---------------	--	---------------	-----------	--------------

■ With plain lens				
	With BA 9s base fitting	White	ZB5AV01	0.018/0.040
		Green	ZB5AV03	0.018/0.040
		Red	ZB5AV04	0.018/0.040
		Orange	ZB5AV05	0.018/0.040
		Blue	ZB5AV06	0.018/0.040
		Clear	ZB5AV07	0.018/0.040

■ With grooved lens (3)				
	With BA 9s base fitting	White	ZB5AV01S	0.017/0.037
		Green	ZB5AV03S	0.017/0.037
		Red	ZB5AV04S	0.017/0.037
		Orange	ZB5AV05S	0.017/0.037
		Blue	ZB5AV06S	0.017/0.037
		Clear	ZB5AV07S	0.017/0.037

814528



ZB5AV01

(1) For order ~ 440...460 V - 60 Hz transformer blocks, please replace «5» in the reference by «8». Example: XB5AV5B1 becomes XB5AV8B1. To order ~ 550...600 V - 60 Hz blocks, please replace «5» by «9». Example: XB5AV5B1 becomes XB5AV9B1.

(2) Only for use with bodies comprising a light source with BA 9s base fitting (incandescent, neon or LED).

(3) For use in bright ambient light conditions (for example, outdoors in sunlight).

Assembly of other products using:
body/contact assemblies: see page 40
accessories: see page 52



Control and signaling units Ø 22

Harmony® XB5, plastic

Specific functions

Pushbuttons for manual overload reset, hour counters, buzzers, fuse carrier

Manual overload reset buttons (travel 10 mm/0.394 in.)

Shape of head	Actuation distance mm/in.	Marking	Color	Reference	Weight kg/lb
Without cap (1)					
	17...120/0.669...4.724	–	–	XB5AA801	0.027/0.060
	120...257/4.724...10.118	–	–	XB5AA802	0.040/0.088
With flush push					
	17...120/0.669...4.724	Without	Green	XB5AA831	0.027/0.060
			Red	XB5AA841	0.027/0.060
			Blue	XB5AA861	0.027/0.060
		O	Red	XB5AA84101	0.027/0.060
		R	Blue	XB5AA86102	0.027/0.060
	120...257/4.724...10.118	Without	Green	XB5AA832	0.040/0.088
			Red	XB5AA842	0.040/0.088
			Blue	XB5AA862	0.040/0.088
		O	Red	XB5AA84201	0.040/0.088
		R	Blue	XB5AA86202	0.040/0.088
With projecting push					
	17...120/0.669...4.724	O	Red	XB5AL84101	0.027/0.060
	120...257/4.724...10.118	O	Red	XB5AL84201	0.040/0.088



XB5AA●●●

Heads + mounting base for potentiometer (2)

Shape of head	Description	For use with	Reference	Weight kg/lb
	For potentiometer with shaft length 45 to 50 mm/1.772 to 1.968 in.	Ø 6 mm/0.236 in. shaft	ZB5AD912	0.032/0.071
		Ø 6.35 mm/0.250 in. shaft	ZB5AD922	0.032/0.071



ZB5AD●●●

Hour counters

Characteristics	Supply voltage V	Reference	Weight kg/lb
Indication 0...9999.9	≈ 12...24 - 50/60 Hz	XB5DSB	0.045/0.099
	~ 120 - 60 Hz	XB5DSG	0.045/0.099
	~ 230...240 - 50 Hz	XB5DSM	0.045/0.099



XB5DS●

Annunciators (IP 40 NEMA 1)

85 db buzzer: 4 kHz, with continuous or intermittent operation (connection diagram: on our website www.schneider-electric.com)	≈ 24 - 50/60 Hz	XB5KSB	0.035/0.077
	~ 120 - 50/60 Hz	XB5KSG	0.035/0.077
	~ 230...240 - 50 Hz	XB5KSM	0.035/0.077



XB5KS●

Fuse carrier

Description	For use with	Reference	Weight kg/lb
Fuse carrier	5 x 20 mm/0.197 x 0.787 in. fuse 6.3 A - 250 V	XB5DT1S	0.022/0.049



XB5DT1S

(1) Colored cap to be ordered separately: see page 52.

(2) Potentiometer not included.

Assembly of other products using accessories: see page 52



XD5PA12



ZD5PA103

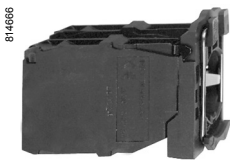

ZD5PA203



ZD5PA12

Joystick controllers (with 54 mm/2.126 in. long operating shaft) (1) Screw clamp terminal connections (Schneider Electric anti-loosening system)

Description	Operation	Spring return to zero position	Reference	Weight kg/lb
Complete products				
2-direction	1 notch 1 N/O contact per direction	Without	XD5PA12	0.060/0.132
		With	XD5PA22	0.060/0.132
4-direction	1 notch 1 N/O contact per direction	Without	XD5PA14	0.077/0.170
		With	XD5PA24	0.077/0.170

Sub-assemblies for joystick controllers

Description	For use with	Reference	Weight kg/lb
Complete body/contact assemblies	2-direction	ZD5PA103	0.049/0.108
	4-direction	ZD5PA203	0.058/0.128
Complete head assemblies with operating shaft	2-direction, stay put	ZD5PA12	0.022/0.049
	2-direction, spring return to zero position	ZD5PA22	0.022/0.049
	4-direction, stay put	ZD5PA14	0.022/0.049
	4-direction, spring return to zero position	ZD5PA24	0.022/0.049

Legends 30 x 48 mm/1.181 x 1.890 in. for engraving	2-direction	Black one side Red reverse	ZBG2201	0.001/0.002
		White one side Yellow reverse	ZBG2401	0.001/0.002
	4-direction	Black one side Red reverse	ZBG4201	0.002/0.004
Legends 48 x 48 mm/1.890 x 1.890 in. for engraving		White one side Yellow reverse	ZBG4401	0.002/0.004

Other versions Joystick controllers and complete body/contact assemblies for joystick controllers with Faston connector terminals (6.35 or 2 x 2.8). Please consult our Customer Care Centre.

(1) Must not be used with standard contact blocks ZBE10● (single) or ZBE20● (double).

Control and signaling units Ø 22

Harmony® XB5, plastic

Body/contact assemblies - Screw clamp terminal connections

To combine with heads, see pages 14 to 38



ZB5AZ009



ZBE101



ZBE203

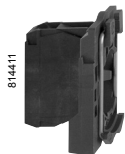

ZB5AZ101



ZBE201

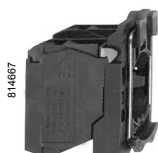

ZB5AZ106

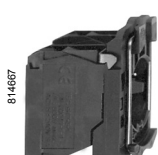

ZB5AZ107



ZBE505



ZB2BE101

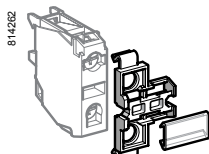

ZBZ001

Body/fixing collar			
For use with	Sold in lots of	Unit reference	Weight kg/lb
Electrical block (contact or light)	10	ZB5AZ009	0.006/0.013

Contact functions (1)
Screw clamp terminal connections (Schneider Electric anti-loosening system)

Contacts for standard applications						
Description	Type of contact			Sold in lots of	Unit reference	Weight kg/lb
		N/O	N/C			
Contact blocks	Single	1	–	5	ZBE101	0.011/0.024
		–	1	5	ZBE102	0.011/0.024
	Double	2	–	5	ZBE203	0.020/0.044
		–	2	5	ZBE204	0.020/0.044
		1	1	5	ZBE205	0.020/0.044
	Single with body/fixing collar	1	–	1	ZB5AZ101	0.021/0.046
		–	1	1	ZB5AZ102	0.021/0.046
		2	–	1	ZB5AZ103	0.030/0.066
		–	2	1	ZB5AZ104	0.030/0.066
		1	1	1	ZB5AZ105	0.030/0.066
		1	2	1	ZB5AZ141	0.040/0.088

Contacts for specific applications							
Application	Type of contact	Description			Sold in lots of	Unit reference	Weight kg/lb
			N/O	N/C			
Low power switching	Single	Standard	1	–	5	ZBE1016	0.012/0.026
			–	1	5	ZBE1026	0.012/0.026
	Dusty environment (2) (IP5X, 50 µm dust)	1	–	5	ZBE1016P	0.012/0.026	
		–	1	5	ZBE1026P	0.012/0.026	
Staggered contacts	Single	Early make N/O	1	–	5	ZBE201	0.011/0.024
			–	1	5	ZBE202	0.011/0.024
	Single with body/fixing collar	Overlapping N/O+N/C	1	1	5	ZB5AZ106	0.030/0.066
			2	–	5	ZB5AZ107	0.030/0.066
			1	–	1	ZBE501	0.020/0.044
High power switching	Single	Standard (3)	–	1	1	ZBE502	0.020/0.044
			2	–	1	ZBE503	0.032/0.071
			–	2	1	ZBE504	0.032/0.071
			1	1	1	ZBE505	0.032/0.071
			1	–	1	ZB2BE101	0.020/0.044
			–	1	1	ZB2BE102	0.020/0.044

Clip-on legend holder, sheet of blank legends and labelling software (5)			
Description	Sold in lots of	Unit reference	Weight kg/lb
Clip-on legend-holder for electrical blocks with screw clamp terminal connections (5). For identification of an XB5A control or signaling unit	10	ZBZ001	0.001/0.002
Sheet of 50 blank legends for legend holder ZBZ001	10	ZBY001	0.023/0.051
«SIS Label» labelling software for legend design (ZBY001 legends) (for design of legends in English, French, German, Italian, Spanish)	1	XBY2U	0.100/0.220

(1) The contact blocks enable variable composition of body/contact assemblies. Maximum number of rows possible: 3. Either 3 rows of 3 single contacts or 1 row of 3 double contacts + 1 row of 3 single contacts (double contacts occupy the first 2 rows). Maximum number of contacts is specified on page 12.
 (2) It is not possible to fit an additional contact block on the back of these contact blocks.
 (3) It is not possible to fit an additional contact block on the back of these contact blocks or to use these contacts with light blocks.
 (4) To be fitted on the back of ZBE505 contacts.
 (5) This legend holder is not compatible with high power switching contacts.

To combine with heads, see page 19

Light blocks with screw clamp terminal connections (Schneider Electric anti-loosening system)

Description	Supply voltage V	Color of light source	Sold in lots of	Unit reference	Weight kg/lb
Integral LED (to combine with heads for integral LED) Protected LED	~ 12 (50/60 Hz)	White	5	ZBVJ1	0.017/0.037
		Green	5	ZBVJ3	0.017/0.037
		Red	5	ZBVJ4	0.017/0.037
		Orange	5	ZBVJ5	0.017/0.037
		Blue	5	ZBVJ6	0.017/0.037
		~ 24 (50/60 Hz)	White	5	ZBVB1
	Green		5	ZBVB3	0.017/0.037
	Red		5	ZBVB4	0.017/0.037
	Orange		5	ZBVB5	0.017/0.037
	Blue		5	ZBVB6	0.017/0.037
	~ 24...120 (50/60 Hz)		White	5	ZBVBG1
		Green	5	ZBVBG3	0.017/0.037
		Red	5	ZBVBG4	0.017/0.037
		Orange	5	ZBVBG5	0.017/0.037
		Blue	5	ZBVBG6	0.017/0.037
		~ 110...120 (50/60 Hz)	White	5	ZBVG1
	Green		5	ZBVG3	0.017/0.037
	Red		5	ZBVG4	0.017/0.037
	Orange		5	ZBVG5	0.017/0.037
	Blue		5	ZBVG6	0.017/0.037
	~ 230...240 (50/60 Hz)		White	5	ZBVM1
		Green	5	ZBVM3	0.017/0.037
		Red	5	ZBVM4	0.017/0.037
		Orange	5	ZBVM5	0.017/0.037
Blue		5	ZBVM6	0.017/0.037	

Flashing light blocks with screw clamp terminal connections (Schneider Electric anti-loosening system)

Integral LED (to combine with heads for integral LED) Protected LED	~ 24 (50/60 Hz)	White	5	ZBV18B1	0.017/0.037
		Green	5	ZBV18B3	0.017/0.037
		Red	5	ZBV18B4	0.017/0.037
		Orange	5	ZBV18B5	0.017/0.037
		Blue	5	ZBV18B6	0.017/0.037
		~ 110...120 (50/60 Hz)	White	5	ZBV18G1
	Green		5	ZBV18G3	0.017/0.037
	Red		5	ZBV18G4	0.017/0.037
	Orange		5	ZBV18G5	0.017/0.037
	Blue		5	ZBV18G6	0.017/0.037
	~ 230...240 (50/60 Hz)		White	5	ZBV18M1
		Green	5	ZBV18M3	0.017/0.037
		Red	5	ZBV18M4	0.017/0.037
		Orange	5	ZBV18M5	0.017/0.037
		Blue	5	ZBV18M6	0.017/0.037

Transformer blocks for 24 V light blocks (1)

For use with	Supply voltage V	Description	Référence	Weight kg/lb
Light blocks with integral LED	~ 400 V - 50 Hz	Transformers 400 V - 24 V ~	ZBV5B (2)	0.090/0.198

Blocks for "test light" function

Light blocks	~ 12 and 24 ~ 24...120	Single module, 1 connecting wire	ZBZG156 (3)	0.010/0.022
Light blocks with integral LED	~ 48...230	Double module, with connecting wires	ZBZM156 (4)	0.010/0.022

LED suppressors

For use with	Supply voltage V	Level of protection	Reference	Weight kg/lb
Light blocks with integral LED	~ 120	25...120 VA	ZBZVG	0.010/0.022
fitted with screw clamp terminal connections	~ 230	30...230 VA	ZBZVM	0.010/0.022

(1) To be used with 2 dummy contact blocks ZBE000.

(2) To order ~ 440...460 V - 60 Hz transformer blocks, please replace "5" in the reference by "8": ZBV5B becomes ZBV8B. To order ~ 550...600 V - 60 Hz transformer blocks, please replace "5" by "9": ZBV5B becomes ZBV9B.

(3) Block for use with ~ light blocks with integral LED types ZBVJ●, ZBVB●, ZBVBG● or with direct supply light block for BA 9s bulb, ZBV6.

(4) Block for use ~ light blocks integral LED types ZBVG●, ZBVM●, see connection on our website www.schneider-electric.com.



ZBVB●



ZBV5B



ZBZG156



ZBZM156



ZBZV●

To combine with heads, see pages 14 to 38

814588



ZB5AZ009

Body/fixing collar				
For use with	Sold in lots of	Unit reference	Weight kg/lb	
Electrical block (contact or light)	10	ZB5AZ009	0.006/0.013	

PF107777



ZBE1015

Contact functions						
Spring clamp terminal connections (1)						
Contacts for standard applications						
Description	Type of contact			Sold in lots of	Unit reference	Weight kg/lb
Contact blocks	Single	1	–	4	ZBE1015	0.011/0.024
		–	1	4	ZBE1025	0.011/0.024
Contact blocks	Single with body/fixing collar	1	–	1	ZB5AZ1015	0.021/0.046
		–	1	1	ZB5AZ1025	0.021/0.046
		2	–	1	ZB5AZ1035	0.030/0.066
		–	2	1	ZB5AZ1045	0.030/0.066
		1	1	1	ZB5AZ1055	0.030/0.066

PF107781



ZB5AZ1015

Light blocks					
Spring clamp terminal connections (1)					
Description	Supply voltage V	Color of light source	Sold in lots of	Unit reference	Weight kg/lb
Integral LED (to combine with heads for integral LED)	≈ 12 (50/60 Hz)	White	4	ZBVJ15	0.016/0.035
		Green	4	ZBVJ35	0.016/0.035
		Red	4	ZBVJ45	0.016/0.035
		Orange	4	ZBVJ55	0.016/0.035
		Blue	4	ZBVJ65	0.016/0.035
protected LED	≈ 24 (50/60 Hz)	White	4	ZBVB15	0.016/0.035
		Green	4	ZBVB35	0.016/0.035
		Red	4	ZBVB45	0.016/0.035
		Orange	4	ZBVB55	0.016/0.035
		Blue	4	ZBVB65	0.016/0.035
	≈ 110...120 (50/60 Hz)	White	4	ZBVG15	0.016/0.035
		Green	4	ZBVG35	0.016/0.035
		Red	4	ZBVG45	0.016/0.035
		Orange	4	ZBVG55	0.016/0.035
		Blue	4	ZBVG65	0.016/0.035
	≈ 230...240 (50/60 Hz)	White	4	ZBVM15	0.016/0.035
		Green	4	ZBVM35	0.016/0.035
		Red	4	ZBVM45	0.016/0.035
		Orange	4	ZBVM55	0.016/0.035
		Blue	4	ZBVM65	0.016/0.035

PF107785E



ZBVB65

814282

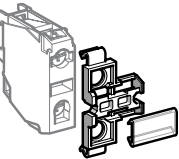

ZBZ001

Sheet of 50 blank legends				
For use with	Sold in lots of	Unit reference	Weight kg/lb	
Legend holder ZBZ001	10	ZBY001	0.023/0.051	

540548



XBY2U

"SIS Label" labelling software (for legends ZBY001)				
For legend design	Sold in lots of	Unit reference	Weight kg/lb	
For English, French, German, Italian, Spanish	1	XBY2U	0.038/0.084	

(1) It is not possible to fit an additional block on the back of these contact or light blocks.

To combine with heads, see pages 14 to 38



ZB5AZ009



ZB5AZ079 + ZB5AZ009

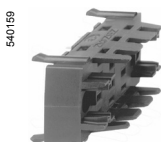

ZBZ01



ZBE701



ZBE702



ZBVB07



Body/fixing collar and accessories specifically for printed circuit board mounting (1)**Accessories required when using adaptor (socket) ZBZ010**

Description	For use with	Sold in lots of	Unit reference	Weight kg/lb
Body/fixing collar	Electrical block (contact or light)	10	ZB5AZ009	0.006/0.013
Fixing collar/pillar	Printed circuit board support (fixing screw ZBZ006 to be ordered separately)	10	ZB5AZ079	0.003/0.007
Fixing screw for printed circuit board	Fixing collar/pillar ZB5AZ079	10	ZBZ006	0.011/0.024



Adapter (socket) (1)

For use with	Thickness of printed circuit board (mm/in.)	Sold in lots of	Unit reference	Weight kg/lb
Electrical block (contact or light)	1.6 ± 0.2/0.063 ± 0.008	10	ZBZ010	0.008/0.018
	2.2 ± 0.2/0.087 ± 0.008	10	ZBZ011	0.008/0.018
	3.2 ± 0.2/0.126 ± 0.008	10	ZBZ012	0.008/0.018

Contact functions (1)**Contacts for standard applications**

Description	Type of contact			Sold in lots of	Unit reference	Weight kg/lb
Contact blocks	Single	1	–	5	ZBE701	0.011/0.024
		–	1	5	ZBE702	0.011/0.024

Contacts for specific applications

Application	Type of contact			Sold in lots of	Unit reference	Weight kg/lb
Low power switching	Single	1	–	5	ZBE7016	0.012/0.026
		–	1	5	ZBE7026	0.012/0.026

Light blocks (1)

Description	Supply voltage V	Color of LED	Sold in lots of	Unit reference	Weight kg/lb
Integral LED (to combine with heads for integral LED)	≈ 24 (50/60 Hz)	White	5	ZBVB17	0.004/0.009
		Green	5	ZBVB37	0.004/0.009
		Red	5	ZBVB47	0.004/0.009
		Orange	5	ZBVB57	0.004/0.009
		Blue	5	ZBVB67	0.004/0.009

Protected
LED

(1) For details of support drilling and of printed circuit board: see our website www.schneider-electric.com.

To combine with heads, see pages 14 to 38

Contact functions (1) Faston connectors (6.35 or 2 x 2.8 mm/0.250 x 0.110 in.)

Contacts for standard applications

Description	Type of contact	Symbol		Sold in lots of	Unit reference	Weight kg/lb	
		N/O	N/C				
Contact blocks	Single	1	–	5	ZBE1013	0.011/0.024	
		–	1	5	ZBE1023	0.011/0.024	
		2	–	5	ZBE2033	0.020/0.044	
	Double	–	2	5	ZBE2043	0.020/0.044	
		1	1	5	ZBE2053	0.020/0.044	
		1	–	1	ZB5AZ1013 (2)	0.021/0.046	
	Single with body/fixing collar	–	1	1	1	ZB5AZ1023 (2)	0.021/0.046
		2	–	1	1	ZB5AZ1033	0.030/0.066
		–	2	1	1	ZB5AZ1043	0.030/0.066
1		1	1	1	ZB5AZ1053	0.030/0.066	



Contacts for specific applications

Application	Type of contact	Description	Symbol		Sold in lots of	Unit reference	Weight kg/lb
			N/O	N/C			
Low power switching	Single	Standard	1	–	5	ZBE10163 (2)	0.012/0.026
			–	1	5	ZBE10263 (2)	0.012/0.026
		Dusty environments (3) (IP 5X, 50 µm dust)	1	–	5	ZBE1016P3 (2)	0.012/0.026
			–	1	5	ZBE1026P3 (2)	0.012/0.026
Staggered contacts	Single	Early make	1	–	5	ZBE2013 (2)	0.011/0.024
			–	1	5	ZBE2023 (2)	0.011/0.024
		Late break	–	1	5	ZBE2023 (2)	0.011/0.024
			1	1	1	ZBE5053	0.033/0.073
High power switching	Single	Standard (4)	1	–	1	ZBE5013	0.021/0.046
			–	1	1	ZBE5023	0.021/0.046
			2	–	1	ZBE5033	0.033/0.073
			–	2	1	ZBE5043	0.033/0.073
			1	1	1	ZBE5053	0.033/0.073

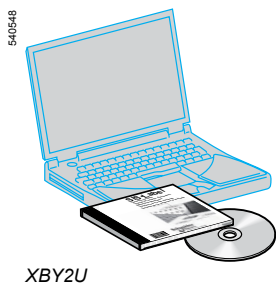
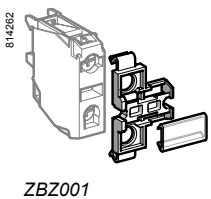

Clip-on legend holder for electrical blocks with screw clamp terminal connections (5)

For use with	Sold in lots of	Unit reference	Weight kg/lb
Identification of an XB5A control or signaling unit	10	ZBZ001	0.001/0.002

Sheet of 50 blank legends

Legend holder ZBZ001	10	ZBY001	0.023/0.051
----------------------	----	--------	-------------

“SIS Label” labelling software (for legends ZBY001)

For legend design for English, French, German, Italian, Spanish	1	XBY2U	0.100/0.220
---	---	-------	-------------

- (1) The contact blocks enable variable composition of body/contact assemblies. Maximum number of rows possible: 3.
Either 3 rows of 3 single contacts or 1 row of 3 double contacts + 1 row of 3 single contacts (double contacts occupy the first 2 rows).
- (2) To order products with screw clamp terminal connections for lugs, replace the 3 at the end of the reference with a 9.
Example: ZBE1013 becomes ZBE1019.
- (3) It is not possible to fit an additional contact block on the back of these contact blocks.
- (4) It is not possible to use these contacts with light blocks.
- (5) This legend holder is not compatible with high power switching contacts.

To combine with heads, see pages 14 to 38



814588

ZB5AZ009

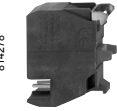

814278

ZBE1014



814279

ZBE1024



814408

ZB5AZ1014



814410

ZB5AZ1024

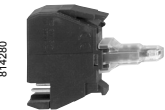

814280

ZBVB4

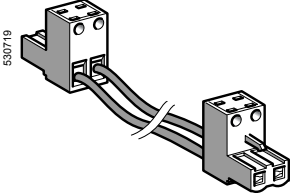

530719

APE1C2250

Body/fixing collar

For use with	Sold in lots of	Unit reference	Weight kg/lb
Electrical block (contact or light)	10	ZB5AZ009	0.006/0.013

Contact functions

Plug-in connector (1)

Contacts for standard applications

Description	Type of contact	Symbol		Sold in lots of	Unit reference	Weight kg/lb
		N/O	N/C			
Contact blocks	Single	1	–	5	ZBE1014	0.011/0.024
		–	1	5	ZBE1024	0.011/0.024
	Single with body/fixing collar	1	–	1	ZB5AZ1014	0.018/0.040
		–	1	1	ZB5AZ1024	0.018/0.040
		2	–	1	ZB5AZ1034	0.026/0.057
		–	2	1	ZB5AZ1044	0.026/0.057
		1	1	1	ZB5AZ1054	0.026/0.057
		1	2	1	ZB5AZ1414	0.036/0.079

Light blocks

Plug-in connector

Description	Supply voltage (V)	Color of light source	Sold in lots of	Unit reference	Weight kg/lb
Integral LED (to combine with heads for integral LED)	~ 24 (50/60 Hz)	White	5	ZBVB14	0.016/0.035
		Green	5	ZBVB34	0.016/0.035
		Red	5	ZBVB44	0.016/0.035
		Orange	5	ZBVB54	0.016/0.035
		Blue	5	ZBVB64	0.016/0.035
		Protected LED	~ 110...120 (50/60 Hz)	White	5
Green	5			ZBVG34	0.016/0.035
Red	5			ZBVG44	0.016/0.035
Orange	5			ZBVG54	0.016/0.035
Blue	5			ZBVG64	0.016/0.035
	~ 230...240 (50/60 Hz)			White	5
		Green	5	ZBVM34	0.016/0.035
		Red	5	ZBVM44	0.016/0.035
		Orange	5	ZBVM54	0.016/0.035
		Blue	5	ZBVM64	0.016/0.035

Connecting cables and connector

Description	Number of connectors	Wire c.s.a. mm ²	Length mm/in.	Sold in lots of	Unit reference	Weight kg/lb
Cables with connectors 2-pin, 5.08 mm/0.200 in. pitch	1	0.75	500/19.685	8	APE1C2150	0.120/0.265
	2	0.75	500/19.685	8	APE1C2250	0.180/0.397
Spring terminal connector 2-pin, 5.08 mm/0.200 in. pitch	–	0.2 to 2.5	–	10	APE1PRE21	0.003/0.007



(1) It is not possible to fit an additional contact block on the back of these contact blocks.

Control and signaling units Ø 22



Harmony® XB5, plastic

Body/contact assemblies + light blocks with integral LED

To combine with:
heads, see pages 19 to 35
contacts, see page 40

Complete body/contact assemblies and light blocks ⁽¹⁾						
Screw clamp terminal connections (Schneider Electric anti-loosening system)						
Light source	Supply voltage V	Type of contact		Color of light source	Reference	Weight kg/lb
						
		N/O	N/C			

Direct supply

 ZB5AW0●●1	Integral LED ~ 24 (50/60 Hz)	1	-	White	ZB5AW0B11	0.032/0.071
				Green	ZB5AW0B31	0.032/0.071
				Red	ZB5AW0B41	0.032/0.071
				Orange	ZB5AW0B51	0.032/0.071
				Blue	ZB5AW0B61	0.032/0.071
		-	1	White	ZB5AW0B12	0.032/0.071
				Green	ZB5AW0B32	0.032/0.071
				Red	ZB5AW0B42	0.032/0.071
				Orange	ZB5AW0B52	0.032/0.071
				Blue	ZB5AW0B62	0.032/0.071
2	-	White	ZB5AW0B13	0.042/0.093		
		Green	ZB5AW0B33	0.042/0.093		
		Red	ZB5AW0B43	0.042/0.093		
		Orange	ZB5AW0B53	0.042/0.093		
		Blue	ZB5AW0B63	0.042/0.093		
1	1	White	ZB5AW0B15	0.042/0.093		
		Green	ZB5AW0B35	0.042/0.093		
		Red	ZB5AW0B45	0.042/0.093		
		Orange	ZB5AW0B55	0.042/0.093		
		Blue	ZB5AW0B65	0.042/0.093		
 ZB5AW0●●3	~ 110...120 (50/60 Hz)	1	-	White	ZB5AW0G11	0.032/0.071
				Green	ZB5AW0G31	0.032/0.071
				Red	ZB5AW0G41	0.032/0.071
				Orange	ZB5AW0G51	0.032/0.071
				Blue	ZB5AW0G61	0.032/0.071
		-	1	White	ZB5AW0G12	0.032/0.071
				Green	ZB5AW0G32	0.032/0.071
				Red	ZB5AW0G42	0.032/0.071
				Orange	ZB5AW0G52	0.032/0.071
				Blue	ZB5AW0G62	0.032/0.071
2	-	White	ZB5AW0G13	0.042/0.093		
		Green	ZB5AW0G33	0.042/0.093		
		Red	ZB5AW0G43	0.042/0.093		
		Orange	ZB5AW0G53	0.042/0.093		
		Blue	ZB5AW0G63	0.042/0.093		
1	1	White	ZB5AW0G15	0.042/0.093		
		Green	ZB5AW0G35	0.042/0.093		
		Red	ZB5AW0G45	0.042/0.093		
		Orange	ZB5AW0G55	0.042/0.093		
		Blue	ZB5AW0G65	0.042/0.093		

Other versions

Complete bodies with Faston connector terminals (6.35 or 2 x 2.8).
Please consult our Customer Care Centre.

(1) Can be fitted with additional contact blocks: see page 40.

To combine with:
heads, see pages 19 to 35
contacts, see page 40

Complete body/contact assemblies and light blocks (1) (continued)
Screw clamp terminal connections (Schneider Electric anti-loosening system)

Light source	Supply voltage V	Type of contact		Color of light source	Reference	Weight kg/lb
		N/O	N/C			
Direct supply (continued)						
Integral LED Protected LED	~ 230...240 (50/60 Hz)	1	–	White	ZB5AW0M11	0.032/0.071
				Green	ZB5AW0M31	0.032/0.071
				Red	ZB5AW0M41	0.032/0.071
				Orange	ZB5AW0M51	0.032/0.071
				Blue	ZB5AW0M61	0.032/0.071
		–	1	White	ZB5AW0M12	0.032/0.071
				Green	ZB5AW0M32	0.032/0.071
				Red	ZB5AW0M42	0.032/0.071
				Orange	ZB5AW0M52	0.032/0.071
				Blue	ZB5AW0M62	0.032/0.071
		2	–	White	ZB5AW0M13	0.042/0.093
				Green	ZB5AW0M33	0.042/0.093
				Red	ZB5AW0M43	0.042/0.093
				Orange	ZB5AW0M53	0.042/0.093
				Blue	ZB5AW0M63	0.042/0.093
		1	1	White	ZB5AW0M15	0.042/0.093
				Green	ZB5AW0M35	0.042/0.093
				Red	ZB5AW0M45	0.042/0.093
				Orange	ZB5AW0M55	0.042/0.093
				Blue	ZB5AW0M65	0.042/0.093

Other versions

Complete bodies with Faston connector terminals (6.35 or 2 x 2.8).
Please consult our Customer Care Centre.

(1) Can be fitted with additional contact blocks: see page 40.



Control and signaling units Ø 22

Harmony® XB5, plastic

Body/light assemblies for pilot lights with integral LED

To combine with:
heads, see page 36
contacts, see page 40



ZB5AV●●

Complete light bodies (fixing collar and light block with integral LED)				
Screw clamp terminal connections (Schneider Electric anti-loosening system)				
Light source	Supply voltage V	Color of light source	Reference	Weight kg/lb
Integral LED protected LED	≈ 12 (50/60 Hz)	White	ZB5AVJ1	0.022/0.049
		Green	ZB5AVJ3	0.022/0.049
		Red	ZB5AVJ4	0.022/0.049
		Orange	ZB5AVJ5	0.022/0.049
		Blue	ZB5AVJ6	0.022/0.049
		≈ 24 (1) (50/60 Hz)	White	ZB5AVB1
Green	ZB5AVB3		0.022/0.049	
Red	ZB5AVB4		0.022/0.049	
Orange	ZB5AVB5		0.022/0.049	
Blue	ZB5AVB6		0.022/0.049	
≈ 24...120 (50/60 Hz)	White		ZB5AVBG1	0.022/0.049
	Green	ZB5AVBG3	0.022/0.049	
	Red	ZB5AVBG4	0.022/0.049	
	Orange	ZB5AVBG5	0.022/0.049	
	Blue	ZB5AVBG6	0.022/0.049	
	~ 110...120 (1) (50/60 Hz)	White	ZB5AVG1	0.022/0.049
Green		ZB5AVG3	0.022/0.049	
Red		ZB5AVG4	0.022/0.049	
Orange		ZB5AVG5	0.022/0.049	
Blue		ZB5AVG6	0.022/0.049	
~ 230...240 (1) (50/60 Hz)		White	ZB5AVM1	0.022/0.049
	Green	ZB5AVM3	0.022/0.049	
	Red	ZB5AVM4	0.022/0.049	
	Orange	ZB5AVM5	0.022/0.049	
	Blue	ZB5AVM6	0.022/0.049	

(1) Complete bodies with Faston connector terminals (6.35 or 2 x 2.8), see page 44.

To combine with:
heads, see page 36
contacts, see page 40



ZB5AVB●156

Complete light bodies with 3-terminal “test” function

(fixing collar and light block with integral LED + pre-wired block for “test light” function)

Screw clamp terminal connections (Schneider Electric anti-loosening system)

Light source	Supply voltage V	Color of light source	Reference	Weight kg/lb
Integral LED Protected LED	≈ 24 (1) (50/60 Hz)	White	ZB5AVB1156	0.022/0.049
		Green	ZB5AVB3156	0.022/0.049
		Red	ZB5AVB4156	0.022/0.049
		Orange	ZB5AVB5156	0.022/0.049
		Blue	ZB5AVB6156	0.022/0.049

Complete bodies with flashing pilot light (fixing collar and light block with integral LED)

Screw clamp terminal connections (Schneider Electric anti-loosening system)

Light source	Supply voltage V	Color of light source	Reference	Weight kg/lb
Integral LED Protected LED	≈ 24 (50/60 Hz)	White	ZB5AV18B1	0.022/0.049
		Green	ZB5AV18B3	0.022/0.049
		Red	ZB5AV18B4	0.022/0.049
		Orange	ZB5AV18B5	0.022/0.049
		Blue	ZB5AV18B6	0.022/0.049
	≈ 110...120 (50/60 Hz)	White	ZB5AV18G1	0.022/0.049
		Green	ZB5AV18G3	0.022/0.049
		Red	ZB5AV18G4	0.022/0.049
		Orange	ZB5AV18G5	0.022/0.049
		Blue	ZB5AV18G6	0.022/0.049
	≈ 230...240 (50/60 Hz)	White	ZB5AV18M1	0.022/0.049
		Green	ZB5AV18M3	0.022/0.049
		Red	ZB5AV18M4	0.022/0.049
		Orange	ZB5AV18M5	0.022/0.049
		Blue	ZB5AV18M6	0.022/0.049



(1) For a ~ 120 or 230 V supply, use complete body **ZB5AVG●** or **ZB5AVM●** with block for “test light” function type **ZBZM156**, see pages 41 and 48.

Control and signaling units Ø 22

Harmony® XB5, plastic

Body/contact assemblies + light blocks with BA 9s base fitting

To combine with:
heads, see page 21
contacts, see page 40

Complete body/contact assemblies and light blocks ⁽¹⁾							
For bulb with BA 9s base fitting (incandescent, neon or LED)							
Screw clamp terminal connections (Schneider Electric anti-loosening system)							
Light source	Supply voltage V	Type of contact		Color of light source	Reference	Weight kg/lb	
							
Direct supply							
BA 9s base fitting bulb, 2.4 W max., not included ⁽²⁾	≤ 250	1	–	–	ZB5AW061	0.031/0.068	
		–	1	–	ZB5AW062	0.031/0.068	
		2	–	–	ZB5AW063	0.041/0.090	
		1	1	–	ZB5AW065	0.041/0.090	
Supply via integral transformer (1.2 VA, 6 V secondary)							
Incandescent BA 9s base fitting bulb, included	~ 110...120 50/60 Hz	1	–	–	ZB5AW031	0.110/0.243	
		1	1	–	ZB5AW035	0.119/0.262	
	~ 230 50 Hz ~ 220...240 60 Hz	1	–	–	ZB5AW041	0.110/0.243	
		1	1	–	ZB5AW045	0.119/0.262	
	~ 400 50 Hz	1	–	–	ZB5AW051	0.110/0.243	
		1	1	–	ZB5AW055	0.119/0.262	
	BA9s base fitting LED, included	~ 110...120 50/60 Hz	1	1	White	ZB5AW03D15	0.119/0.262
					Green	ZB5AW03D35	0.119/0.262
					Red	ZB5AW03D45	0.119/0.262
					Orange	ZB5AW03D55	0.119/0.262
Blue					ZB5AW03D65	0.119/0.262	
~ 230 50 Hz ~ 220...240 60 Hz		1	1	White	ZB5AW04D15	0.119/0.262	
				Green	ZB5AW04D35	0.119/0.262	
				Red	ZB5AW04D45	0.119/0.262	
				Orange	ZB5AW04D55	0.119/0.262	
				Blue	ZB5AW04D65	0.119/0.262	
~ 400 50/60 Hz		1	1	White	ZB5AW05D15	0.120/0.265	
				Green	ZB5AW05D35	0.120/0.265	
				Red	ZB5AW05D45	0.120/0.265	
				Orange	ZB5AW05D55	0.120/0.265	
				Blue	ZB5AW05D65	0.120/0.265	
Other versions		Complete bodies with integral transformer incorporating Faston connector terminals (6.35 or 2 x 2.8). Please consult our Customer Care Centre.					

⁽¹⁾ Can be fitted with additional contact blocks: see page 40.
⁽²⁾ Bulb to be ordered separately: see page 64.



ZB5AW065

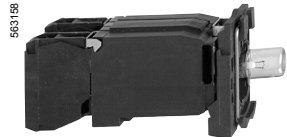

ZB5AW035

To combine with:
heads, see page 37
contacts, see page 40

Light blocks**Screw clamp terminal connections** (Schneider Electric anti-loosening system)

Description	Supply voltage V	Sold in lots of	Unit reference	Weight kg/lb
Direct supply for BA 9s base fitting bulb, 2.4 W max., not included (1)	≤ 250	5	ZBV6	0.016/0.035

Complete light bodies (fixing collar and light block)**For bulb with BA 9s base fitting (incandescent, neon or LED)****Screw clamp terminal connections** (Schneider Electric anti-loosening system)

Light source	Supply voltage V	Color of light source	Reference	Weight kg/lb
Direct supply				
BA 9s base fitting bulb, 2.4 W max, not included (1)	≤ 250	–	ZB5AV6	0.022/0.049
Supply via integral transformer (1.2 VA, 6 V secondary)				
BA 9s base fitting incandescent bulb, included	~ 110...120 - 50/60 Hz	–	ZB5AV3	0.099/0.218
	~ 230 - 50 Hz	–	ZB5AV4	0.099/0.218
	~ 220...240 - 60 Hz	–	ZB5AV5	0.099/0.218
	~ 400 - 50 Hz	–	ZB5AV5	0.099/0.218
	~ 440...480 - 60 Hz	–	ZB5AV8	0.099/0.218
	~ 550...600 - 60 Hz	–	ZB5AV9	0.099/0.218

BA 9s base fitting LED, included	~ 110...120 - 50/60 Hz	White	ZB5AV3D1	0.102/0.225
		Green	ZB5AV3D3	0.102/0.225
		Red	ZB5AV3D4	0.102/0.225
		Orange	ZB5AV3D5	0.102/0.225
		Blue	ZB5AV3D6	0.102/0.225
	~ 230 - 50 Hz ~ 220...240 - 60 Hz	White	ZB5AV4D1	0.102/0.225
		Green	ZB5AV4D3	0.102/0.225
		Red	ZB5AV4D4	0.102/0.225
		Orange	ZB5AV4D5	0.102/0.225
		Blue	ZB5AV4D6	0.102/0.225
	~ 400 - 50/60 Hz	White	ZB5AV5D1	0.102/0.225
		Green	ZB5AV5D3	0.102/0.225
		Red	ZB5AV5D4	0.102/0.225
		Orange	ZB5AV5D5	0.102/0.225
		Blue	ZB5AV5D6	0.102/0.225

Complete light bodies with 3-terminal “test” function (fixing collar + light block)**For bulb with BA 9s base fitting (incandescent, neon or LED)****Screw clamp terminal connections** (Schneider Electric anti-loosening system)

Light source	Supply voltage V	Reference	Weight kg/lb
Direct supply			
BA 9s base fitting bulb, 2.4 W max, not included (1)	≤ 250	ZB5AV156	0.021/0.046

Other versions Complete bodies with Faston connector terminals (6.35 or 2 x 2.8), see page 44.

(1) Bulb to be ordered separately, see page 64.



ZB5AV6



ZB5AV3



ZB5AV156

Control and signaling units Ø 22

Harmony® XB5, plastic

Accessories for heads: unmarked pushbutton caps

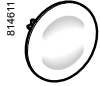

ZBA●

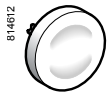

ZBL●

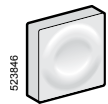

ZBC1

Pushbutton caps - unmarked

For use with	Type of push	Color	Sold in lots of	Unit reference	Weight kg/lb
Plastic pushbuttons					
ZBABA0 and ZB5AA0 circular pushbutton heads supplied without cap	Flush	White	10	ZBA1	0.001/0.002
		Black	10	ZBA2	0.001/0.002
		Green	10	ZBA3	0.001/0.002
		Red	10	ZBA4	0.001/0.002
		Yellow	10	ZBA5	0.001/0.002
		Blue	10	ZBA6	0.001/0.002
		6 colors (1)	1	ZBA9	0.006/0.013
	Projecting	White	10	ZBL1	0.001/0.002
		Black	10	ZBL2	0.001/0.002
		Green	10	ZBL3	0.001/0.002
		Red	10	ZBL4	0.001/0.002
		Yellow	10	ZBL5	0.001/0.002
		Blue	10	ZBL6	0.001/0.002
		6 colors (1)	1	ZBL9	0.006/0.013
ZB5CA0 square pushbutton heads supplied without cap	Flush	White	10	ZBC1	0.001/0.002
		Black	10	ZBC2	0.001/0.002
		Green	10	ZBC3	0.001/0.002
		Red	10	ZBC4	0.001/0.002
		Yellow	10	ZBC5	0.001/0.002
		Blue	10	ZBC6	0.001/0.002

(1) Set of 6 different colored caps: White, Black, Green, Red, Yellow, Blue.

Control and signaling units Ø 22

Harmony® XB5, plastic

Accessories for heads: marked pushbutton caps



Pushbutton caps - marked

For use with	Type of push	Marking		Color of cap	Unit reference	Weight kg/lb
		Text	Color			
Plastic pushbuttons						
ZBABA0 and ZB5AA0 circular pushbutton heads supplied without cap (sold in lots of 10)	Flush	I (1)	White	Green	ZBA331	0.001/0.002
			Black	White	ZBA131	0.001/0.002
		II	White	Green	ZBA336	0.001/0.002
			Black	White	ZBA136	0.001/0.002
		III	White	Green	ZBA337	0.001/0.002
			Black	White	ZBA137	0.001/0.002
		IV	White	Green	ZBA338	0.001/0.002
			Black	White	ZBL138	0.001/0.002
START (1)			White	Green	ZBA333	0.001/0.002
			Black	White	ZBA133	0.001/0.002
ON			White	Green	ZBA341	0.001/0.002
			Black	White	ZBA141	0.001/0.002
MARCHE			White	Green	ZBA342	0.001/0.002
			Black	White	ZBA142	0.001/0.002
UP (1)			Black	White	ZBA343	0.001/0.002
DOWN (1)			White	Black	ZBA344	0.001/0.002
 (1)			White	Black	ZBA245	0.001/0.002
			Black	White	ZBA145	0.001/0.002
↑ (2)			White	Black	ZBA335	0.001/0.002
			Black	White	ZBA334	0.001/0.002
O (1)			White	Red	ZBA432	0.001/0.002
			Black		ZBA232	0.001/0.002
ARRET			White	Red	ZBA433	0.001/0.002
			Black		ZBA233	0.001/0.002
STOP (1)			White	Red	ZBA434	0.001/0.002
			Black		ZBA234	0.001/0.002
OFF			White	Red	ZBA435	0.001/0.002
			Black		ZBA235	0.001/0.002
			White	Green	ZBA346	0.001/0.002
R (1)			White	Blue	ZBA639	0.001/0.002
+			White	Black	ZBA2934	0.001/0.002
-			White	Black	ZBA2935	0.001/0.002

(1) Double injection moulded marking.

(2) Can be clipped-in at 90° steps, through 360°

814334



ZBP0

Transparent boots for pushbuttons (1)

Description	For use with plastic pushbuttons	Sold in lots of	Unit reference	Weight kg/lb
Single boots (2)	Flush with circular head	10	ZBPA	0.002/0.004
	Projecting with circular head and push-push version	10	ZBP0	0.002/0.004
	Flush or projecting with circular head for food industry applications	10	ZBP0A	0.002/0.004

Colored boots

Description	Color	For use with	Sold in lots of	Unit reference	Weight kg/lb
Colored boots (can be replaced without dismantling the head)	White	ZB5AP1S	10	ZBP011	0.003/0.007
	Black	ZB5AP2S	10	ZBP012	0.003/0.007
	Green	ZB5AP3S	10	ZBP013	0.003/0.007
	Red	ZB5AP4S	10	ZBP014	0.003/0.007
	Yellow	ZB5AP5S	10	ZBP015	0.003/0.007
	Blue	ZB5AP6S	10	ZBP016	0.003/0.007
Clear membrane	Transparent	ZB5AP●83	10	ZBP017	0.003/0.007

(1) Boots for multiple-headed pushbuttons: see page 23.

(2) Permissible panel thickness 1 to 5 mm, cannot be used with legend holders.

DF-540779



ZBV01•3

Lens caps

For use with	Color	Sold in lots of	Unit reference	Weight kg/lb
Circular lens caps for light sources with integral LED				
Pilot lights	White	10	ZBV0113	0.002/0.004
	Green	10	ZBV0133	0.002/0.004
	Red	10	ZBV0143	0.002/0.004
	Orange	10	ZBV0153	0.002/0.004
	Blue	10	ZBV0163	0.002/0.004
	5 different colored grooved lenses (1)	10	ZBV0103S	0.010/0.022
Illuminated pushbuttons, with flush push	White	10	ZBW9113	0.002/0.004
	Green	10	ZBW9133	0.002/0.004
	Red	10	ZBW9143	0.002/0.004
	Orange	10	ZBW9153	0.002/0.004
	Blue	10	ZBW9163	0.002/0.004
Illuminated pushbuttons, with projecting push	White	10	ZBW9313	0.002/0.004
	Green	10	ZBW9333	0.002/0.004
	Red	10	ZBW9343	0.002/0.004
	Orange	10	ZBW9353	0.002/0.004
	Blue	10	ZBW9363	0.002/0.004
Square lens caps for plastic pushbuttons				
Pilot lights	White	10	ZBCV0113	0.002/0.004
	Green	10	ZBCV0133	0.002/0.004
	Red	10	ZBCV0143	0.002/0.004
	Orange	10	ZBCV0153	0.002/0.004
	Blue	10	ZBCV0163	0.002/0.004
Illuminated pushbuttons, with flush push	White	10	ZBCW9113	0.002/0.004
	Green	10	ZBCW9133	0.002/0.004
	Red	10	ZBCW9143	0.002/0.004
	Orange	10	ZBCW9153	0.002/0.004
	Blue	10	ZBCW9163	0.002/0.004
Illuminated pushbuttons, with projecting push	White	10	ZBCW9313	0.002/0.004
	Green	10	ZBCW9333	0.002/0.004
	Red	10	ZBCW9343	0.002/0.004
	Orange	10	ZBCW9353	0.002/0.004
	Blue	10	ZBCW9363	0.002/0.004
Circular lens caps for light sources with BA 9s fitting				
Pilot lights	White	10	ZBV011	0.002/0.004
	Green	10	ZBV013	0.002/0.004
	Red	10	ZBV014	0.002/0.004
	Orange	10	ZBV015	0.002/0.004
	Blue	10	ZBV016	0.002/0.004
	Clear	10	ZBV017	0.002/0.004
	Illuminated pushbuttons, with flush push	White	10	ZBW911
Green		10	ZBW913	0.002/0.004
Red		10	ZBW914	0.002/0.004
Orange		10	ZBW915	0.002/0.004
Blue		10	ZBW916	0.002/0.004
Clear		10	ZBW917	0.002/0.004
Illuminated pushbuttons, with projecting push		White	10	ZBW931
	Green	10	ZBW933	0.002/0.004
	Red	10	ZBW934	0.002/0.004
	Orange	10	ZBW935	0.002/0.004
	Blue	10	ZBW936	0.002/0.004
	Clear	10	ZBW937	0.002/0.004

(1) Clear, Green, Red, Orange, Blue.

DF-540780



ZBV01•

Control and signaling units Ø 22

Harmony® XB5, plastic

8 x 27 mm legends with 30 x 40 mm legend holders



ZBZ34

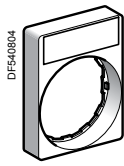

ZBY•H101

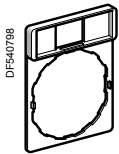

ZBZ32

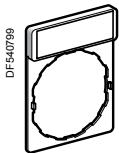

ZBY•101

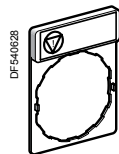

ZBY4140

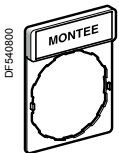

ZBY2107

30 x 40 mm/1.181 x 1.575 in. legend holders (flush mounting with bezel) for 8 x 27 mm/0.315 x 1.063 in. legends (1)

Description	Legend		Sold in lots of	Unit reference	Weight kg/lb
	Color	Marking			
Without legend	–	–	10	ZBZ34	0.003/0.007
With blank legend	Black or Red background	–	10	ZBY2H101	0.004/0.009
	White or Yellow background	–	10	ZBY4H101	0.004/0.009

Standard (30 x 40 mm/1.181 x 1.575 in.) legend holders for 8 x 27 mm /0.315 x 1.063 in. legends (1)

Description	Legend		Sold in lots of	Unit reference	Weight kg/lb		
	Color	Marking					
Without legend	–	–	10	ZBZ32	0.001/0.002		
With blank legend (for engraving)	Black or Red background	–	10	ZBY2101	0.002/0.004		
	White or Yellow background	–	10	ZBY4101	0.002/0.004		
With 8 x 27 mm /0.315 x 1.063 in. legend (with International marking)	Black or Red background (2)	O (Black background)	10	ZBY2146	0.002/0.004		
		O (Red background)	10	ZBY2931	0.002/0.004		
		I	10	ZBY2147	0.002/0.004		
		II	10	ZBY2148	0.002/0.004		
		O-I	10	ZBY2178	0.002/0.004		
		I-II	10	ZBY2179	0.002/0.004		
		I-O-II	10	ZBY2186	0.002/0.004		
		AUTO	10	ZBY2115	0.002/0.004		
		STOP	10	ZBY2304	0.002/0.004		
		Yellow background		10	ZBY4140 (3)	0.002/0.004	
		With 8 x 27 mm /0.315 x 1.063 in. legend (with French language marking)	Black or Red background (2)	ARRET (Red background)	10	ZBY2104	0.002/0.004
				ARRET (Black background)	10	ZBY0104	0.002/0.004
				ARRET GENERAL	10	ZBY2129	0.002/0.004
				ARRET REARMEMENT	10	ZBY2133	0.002/0.004
				ARRET-MARCHE	10	ZBY2166	0.002/0.004
ARRIERE	10			ZBY2106	0.002/0.004		
AUTO CYCLE-CYCLE	10			ZBY2198	0.002/0.004		
AUTO CYCLE-MAIN	10			ZBY2199	0.002/0.004		
AUTO-MAIN	10			ZBY2164	0.002/0.004		
AUTO-O-MAIN	10			ZBY2185	0.002/0.004		
AVANT	10			ZBY2105	0.002/0.004		
AVANT-O-ARRIERE	10			ZBY2184	0.002/0.004		
C-P-C-NORMAL	10			ZBY2165	0.002/0.004		
CYCLE-MAIN	10			ZBY2197	0.002/0.004		
DECLENCHEMENT	10			ZBY2132	0.002/0.004		
DEFAULT (Black background)	10	ZBY2134	0.002/0.004				
DEFAULT (Red background)	10	ZBY2135	0.002/0.004				
DEPART CYCLE	10	ZBY2195	0.002/0.004				
DESCENTE	10	ZBY2108	0.002/0.004				
DROITE	10	ZBY2109	0.002/0.004				
ENCLENCHEMENT	10	ZBY2131	0.002/0.004				
EN SERVICE	10	ZBY2111	0.002/0.004				
FERMETURE	10	ZBY2114	0.002/0.004				
GAUCHE	10	ZBY2110	0.002/0.004				
HORS SERVICE	10	ZBY2112	0.002/0.004				
HORS-EN	10	ZBY2167	0.002/0.004				
LENT	10	ZBY2127	0.002/0.004				
MAIN	10	ZBY2116	0.002/0.004				
MARCHE	10	ZBY2103	0.002/0.004				
MONTEE	10	ZBY2107	0.002/0.004				
OUVERTURE	10	ZBY2113	0.002/0.004				
PHASE/PHASE	10	ZBY2196	0.002/0.004				
REARMEMENT (Red background)	10	ZBY2123	0.002/0.004				
REARMEMENT (Black background)	10	ZBY0123	0.002/0.004				
SOUS TENSION	10	ZBY2126	0.002/0.004				
VITE	10	ZBY2128	0.002/0.004				
Red background	ARRET D'URGENCE	10	ZBY2130 (3)	0.002/0.004			

(1) For legends, see pages 58 to 60.

(2) "Start" functions: White letters on Black background. "Stop" functions: White letters on Red background (unless otherwise specified above).

(3) For complying with EN/ISO 13850 standard, paragraph 4.4.6., Emergency Stop function logo has been added.

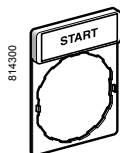

ZBY2303

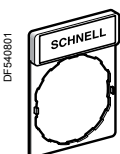

ZBY2228

Standard (30 x 40 mm/1.181 x 1.575 in.) legend holders with 8 x 27 mm /0.315 x 1.063 in. legends (continued)

Description	Legend		Sold in lots of	Reference	Weight kg/lb		
	Color	Marking					
With legend (with English language marking)	Black or Red background (1)	AUTO-HAND	10	ZBY2364	0.002/0.004		
		AUTO-O-HAND	10	ZBY2385	0.002/0.004		
		CLOSE	10	ZBY2314	0.002/0.004		
		DOWN	10	ZBY2308	0.002/0.004		
		FAST	10	ZBY2328	0.002/0.004		
		FORWARD	10	ZBY2305	0.002/0.004		
		HAND	10	ZBY2316	0.002/0.004		
		HAND-OFF-AUTO	10	ZBY2387	0.002/0.004		
		INCH	10	ZBY2321	0.002/0.004		
		LEFT	10	ZBY2310	0.002/0.004		
		OFF	10	ZBY2312	0.002/0.004		
		OFF-ON	10	ZBY2367	0.002/0.004		
		ON	10	ZBY2311	0.002/0.004		
		OPEN	10	ZBY2313	0.002/0.004		
		POWER ON	10	ZBY2326	0.002/0.004		
		RESET (Red background)	10	ZBY2323	0.002/0.004		
		RESET (Black background)	10	ZBY2322	0.002/0.004		
		REVERSE	10	ZBY2306	0.002/0.004		
		RIGHT	10	ZBY2309	0.002/0.004		
		RUN	10	ZBY2334	0.002/0.004		
		SLOW	10	ZBY2327	0.002/0.004		
		START	10	ZBY2303	0.002/0.004		
		STOP-START	10	ZBY2366	0.002/0.004		
		UP	10	ZBY2307	0.002/0.004		
			Red background	EMERGENCY STOP	10	ZBY2330 (2)	0.002/0.004
		With legend (with German language marking)	Black or Red background (1)	AB	10	ZBY2208	0.002/0.004
				AUF	10	ZBY2207	0.002/0.004
AUS	10			ZBY2204	0.002/0.004		
AUS-EIN	10			ZBY2266	0.002/0.004		
AUS-IN BETRIEB	10			ZBY2267	0.002/0.004		
AUS-RÜCKSTELLUNG	10			ZBY2233	0.002/0.004		
AUSSCHALTEN	10			ZBY2232	0.002/0.004		
AUTO-HAND	10			ZBY2364	0.002/0.004		
AUTO-O-HAND	10			ZBY2385	0.002/0.004		
AUTOZYKL-HAND	10			ZBY2299	0.002/0.004		
AUTOZYKL- 1 ZYKL	10			ZBY2298	0.002/0.004		
C-P-C-NORMAL	10			ZBY2265	0.002/0.004		
EIN	10			ZBY2203	0.002/0.004		
EINSCHALTEN	10			ZBY2231	0.002/0.004		
HAND	10			ZBY2316	0.002/0.004		
LANGSAM	10			ZBY2227	0.002/0.004		
LINKS	10			ZBY2210	0.002/0.004		
NOT-AUS (Red background)	10			ZBY2230	0.002/0.004		
ÖFFNEN	10			ZBY2213	0.002/0.004		
RECHTS	10			ZBY2209	0.002/0.004		
RÜCKSTELLUNG	10			ZBY2223	0.002/0.004		
SCHLIESSEN	10			ZBY2214	0.002/0.004		
SCHNELL	10			ZBY2228	0.002/0.004		
SPANNUNG EIN	10			ZBY2226	0.002/0.004		
STEUERUNG AUS	10			ZBY2212	0.002/0.004		
STEUERUNG EIN	10			ZBY2211	0.002/0.004		
STÖRUNG (Black background)	10			ZBY2234	0.002/0.004		
STÖRUNG (Red background)	10			ZBY2235	0.002/0.004		
VOR	10			ZBY2205	0.002/0.004		
VOR-O-ZURÜCK	10			ZBY2284	0.002/0.004		
ZURÜCK	10			ZBY2206	0.002/0.004		
ZYKLUS-HAND	10			ZBY2297	0.002/0.004		
ZYKLUSSTART	10	ZBY2295	0.002/0.004				
	Red background	NOT-HALT	10	ZBY2229 (2)	0.002/0.004		
	Yellow background	NOT-HALT	10	ZBY22420001 (2)	0.002/0.004		

(1) "Start" functions: White letters on Black background. "Stop" functions: White letters on Red background (unless otherwise specified above).

(2) For complying with EN/ISO 13850 standard, paragraph 4.4.6., Emergency Stop function logo  has been added.

Control and signaling units Ø 22

Harmony® XB5, plastic

Legends 8 x 27 mm

8 x 27 mm/0.315 x 1.063 in. marked legends (for 30 x 40 mm/1.181 x 1.575 in. legend holders ZBZ32 and ZBZ34)

Language	Color of background	Marking	Sold in lots of	Reference	Weight kg/lb		
Without	Black or Red	–	10	ZBY0101	0.001/0.002		
	White or Yellow	–	10	ZBY0102	0.001/0.002		
International	Black or Red (1)	O (Black background)	10	ZBY02146	0.001/0.002		
		O (Red background)	10	ZBY02931	0.001/0.002		
		I	10	ZBY02147	0.001/0.002		
		II	10	ZBY02148	0.001/0.002		
		O-I	10	ZBY02178	0.001/0.002		
		I-II	10	ZBY02179	0.001/0.002		
		I-O-II	10	ZBY02186	0.001/0.002		
		AUTO	10	ZBY02115	0.001/0.002		
		STOP	10	ZBY02304	0.001/0.002		
		Yellow		10	ZBY0140 (2)	0.001/0.002	
		French	Black or Red (1)	ARRET (Red background)	10	ZBY02104	0.001/0.002
				ARRET (Black background)	10	ZBY00104	0.001/0.002
				ARRET GENERAL	10	ZBY02129	0.001/0.002
ARRET REARMEMENT	10			ZBY02133	0.001/0.002		
ARRET-MARCHE	10			ZBY02166	0.001/0.002		
ARRIERE	10			ZBY02106	0.001/0.002		
AUTO CYCLE-CYCLE	10			ZBY02198	0.001/0.002		
AUTO CYCLE-MAIN	10			ZBY02199	0.001/0.002		
AUTO-MAIN	10			ZBY02164	0.001/0.002		
AUTO-O-MAIN	10			ZBY02185	0.001/0.002		
AVANT	10			ZBY02105	0.001/0.002		
AVANT-O-ARRIERE	10			ZBY02184	0.001/0.002		
C-P-C-NORMAL	10			ZBY02165	0.001/0.002		
CYCLE-MAIN	10			ZBY02197	0.001/0.002		
DECLENCHEMENT	10			ZBY02132	0.001/0.002		
DEFAUT (Black background)	10			ZBY02134	0.001/0.002		
DEFAUT (Red background)	10			ZBY02135	0.001/0.002		
DEPART CYCLE	10			ZBY02195	0.001/0.002		
DESCENTE	10			ZBY02108	0.001/0.002		
DROITE	10			ZBY02109	0.001/0.002		
ENCLENCHEMENT	10			ZBY02131	0.001/0.002		
EN SERVICE	10			ZBY02111	0.001/0.002		
FERMETURE	10			ZBY02114	0.001/0.002		
GAUCHE	10			ZBY02110	0.001/0.002		
HORS SERVICE	10			ZBY02112	0.001/0.002		
HORS-EN	10			ZBY02167	0.001/0.002		
LENT	10			ZBY02127	0.001/0.002		
MAIN	10			ZBY02116	0.001/0.002		
MARCHE	10			ZBY02103	0.001/0.002		
MONTEE	10			ZBY02107	0.001/0.002		
OUVERTURE	10			ZBY02113	0.001/0.002		
PHASE/PHASE	10			ZBY02196	0.001/0.002		
REARMEMENT (Red background)	10			ZBY02123	0.001/0.002		
REARMEMENT (Black background)	10			ZBY00123	0.001/0.002		
SOUS TENSION	10			ZBY02126	0.001/0.002		
VITE	10			ZBY02128	0.001/0.002		
Red	ARRET D'URGENCE		10	ZBY02130 (2)	0.001/0.002		

(1) "Start" functions: White letters on Black background. "Stop" functions: White letters on Red background (unless otherwise specified above)

(2) For complying with EN/ISO 13850 standard, paragraph 4.4.6., Emergency Stop function logo  has been added.

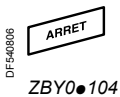
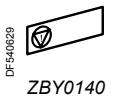
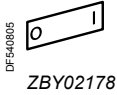

8 x 27 mm/0.315 x 1.063 in. marked legends (for 30 x 40 mm/1.181 x 1.575 in. legend holders ZBZ32 and ZBZ34) (continued)

Language	Color of background	Marking	Sold in lots of	Reference	Weight kg/lb		
English	Black or Red (1)	AUTO-HAND	10	ZBY02364	0.001/0.002		
		AUTO-O-HAND	10	ZBY02385	0.001/0.002		
		CLOSE	10	ZBY02314	0.001/0.002		
		DOWN	10	ZBY02308	0.001/0.002		
		FAST	10	ZBY02328	0.001/0.002		
		FORWARD	10	ZBY02305	0.001/0.002		
		HAND	10	ZBY02316	0.001/0.002		
		HAND-OFF-AUTO	10	ZBY02387	0.001/0.002		
		INCH	10	ZBY02321	0.001/0.002		
		LEFT	10	ZBY02310	0.001/0.002		
		OFF	10	ZBY02312	0.001/0.002		
		OFF-ON	10	ZBY02367	0.001/0.002		
		ON	10	ZBY02311	0.001/0.002		
		OPEN	10	ZBY02313	0.001/0.002		
		POWER ON	10	ZBY02326	0.001/0.002		
		RESET (Red background)	10	ZBY02323	0.001/0.002		
		RESET (Black background)	10	ZBY02322	0.001/0.002		
		REVERSE	10	ZBY02306	0.001/0.002		
		RIGHT	10	ZBY02309	0.001/0.002		
		RUN	10	ZBY02334	0.001/0.002		
		SLOW	10	ZBY02327	0.001/0.002		
		START	10	ZBY02303	0.001/0.002		
		STOP-START	10	ZBY02366	0.001/0.002		
		UP	10	ZBY02307	0.001/0.002		
			Red	EMERGENCY STOP	10	ZBY02330 (2)	0.001/0.002
		German	Black or Red (1)	AB	10	ZBY02208	0.001/0.002
				AUF	10	ZBY02207	0.001/0.002
AUS	10			ZBY02204	0.001/0.002		
AUS-EIN	10			ZBY02266	0.001/0.002		
AUS-IN BETRIEB	10			ZBY02267	0.001/0.002		
AUS-RÜCKSTELLUNG	10			ZBY02233	0.001/0.002		
AUSSCHALTEN	10			ZBY02232	0.001/0.002		
AUTO-HAND	10			ZBY02364	0.001/0.002		
AUTO-O-HAND	10			ZBY02385	0.001/0.002		
AUTOZYKL-HAND	10			ZBY02299	0.001/0.002		
AUTOZYKL- 1 ZYKL	10			ZBY02298	0.001/0.002		
C-P-C-NORMAL	10			ZBY02265	0.001/0.002		
EIN	10			ZBY02203	0.001/0.002		
EINSCHALTEN	10			ZBY02231	0.001/0.002		
HAND	10			ZBY02316	0.001/0.002		
LANGSAM	10			ZBY02227	0.001/0.002		
LINKS	10			ZBY02210	0.001/0.002		
NOT-AUS (Red background)	10			ZBY02230	0.001/0.002		
ÖFFNEN	10			ZBY02213	0.001/0.002		
RECHTS	10			ZBY02209	0.001/0.002		
RÜCKSTELLUNG	10			ZBY02223	0.001/0.002		
SCHLIESSEN	10			ZBY02214	0.001/0.002		
SCHNELL	10			ZBY02228	0.001/0.002		
SPANNUNG EIN	10			ZBY02226	0.001/0.002		
STEUERUNG AUS	10			ZBY02212	0.001/0.002		
STEUERUNG EIN	10			ZBY02211	0.001/0.002		
STÖRUNG (Black background)	10			ZBY02234	0.001/0.002		
STÖRUNG (Red background)	10			ZBY02235	0.001/0.002		
VOR	10			ZBY02205	0.001/0.002		
VOR-O-ZURÜCK	10			ZBY02284	0.001/0.002		
ZURÜCK	10			ZBY02206	0.001/0.002		
ZYKLUS-HAND	10			ZBY02297	0.001/0.002		
ZYKLUSSTART	10			ZBY02295	0.001/0.002		
	Red			NOT-HALT	10	ZBY02229 (2)	0.001/0.002
	Yellow			NOT-HALT	10	ZBY022420001 (2)	0.001/0.002

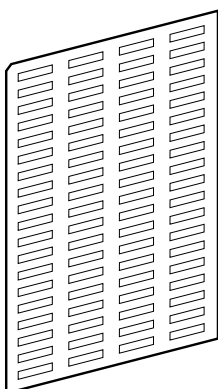

Sheets of peel-off legends (with backing board and protective transparent cover)

Description	For use with	Sold in lots of	Unit reference	Weight kg/lb
Sheet of 76 legends 8 x 27 mm /0.315 x 1.063 in.	30 x 40 mm/1.181 x 1.575 in. legend holder ZBZ32 and ZBZ34	10	ZBY4100	0.043/0.095

(1) "Start" functions: White letters on Black background. "Stop" functions: White letters on Red background (unless otherwise specified above).

(2) For complying with EN/ISO 13850 standard, paragraph 4.4.6., Emergency Stop function logo  has been added.

Control and signaling units Ø 22

Harmony® XB5, plastic

Legend holders for 18 x 27 mm legends

18 x 27 mm legends for engraving or printing

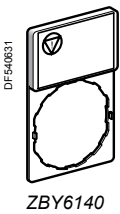
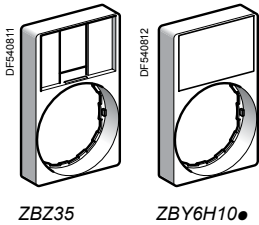
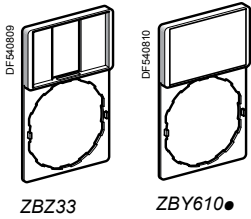

Standard (30 x 50 mm/1.181 x 1.968 in.) legend holders for 18 x 27 mm/0.709 x 1.063 in. legends

Description	Color of background	Sold in lots of	Unit reference	Weight kg/lb
Without legend	–	10	ZBZ33	0.001/0.002
With blank legend	Black or Red	10	ZBY6101	0.002/0.004
	White or Yellow	10	ZBY6102	0.002/0.004
	Yellow	10	ZBY6140 (1)	0.002/0.004

30 x 50 mm/1.181 x 1.968 in. legend holder (flush mounting with bezel) for 18 x 27 mm/0.709 x 1.063 in. legends

Description	Color of background	Sold in lots of	Unit reference	Weight kg/lb
Without legend	–	10	ZBZ35	0.003/0.007
With blank legend	Black or Red	10	ZBY6H101	0.004/0.009
	White or Yellow	10	ZBY6H102	0.004/0.009

18 x 27 mm/0.709 x 1.063 in. legends for engraving (for 30 x 50 mm/1.181 x 1.968 in. legend-holders)

Description mm	Language	Marking	Sold in lots of	Unit reference	Weight kg/lb
Black or Red background	–	Without	10	ZBY5101	0.001/0.002
White or Yellow background	–	Without	10	ZBY5102	0.001/0.002
Yellow background	International		10	ZBY6140 (1)	0.001/0.002
	French	ARRET D'URGENCE	10	ZBY55130 (1)	0.001/0.002
	English	EMERGENCY STOP	10	ZBY55330 (1)	0.001/0.002

Sheets of peel-off legends (with backing board and protective transparent cover)

Description	For use with	Sold in lots of	Unit reference	Weight kg/lb
Sheet of 40 18 x 27 mm/0.709 x 1.063 in. legends	30 x 50 mm/1.181 x 1.968 in. ZBZ33 and ZBZ35 legend holder	10	ZBY5100	0.044/0.097

(1) For complying with EN/ISO 13850 standard, paragraph 4.4.6., Emergency Stop function logo has been added.

Control and signaling units Ø 22

Harmony® XB5, plastic

Legends, for insertion, for printing, pre-printed, labelling software, circular legends

Legends for XB5A pushbuttons, illuminated pushbuttons and pilot lights

Description	Language	Marking	Sold in lots of	Unit reference	Weight kg/lb
Sheets of 66 circular peel-off, transparent, self-adhesive legends	–	Without	10	ZBY1101	0.017/0.037
Strips of 66 circular peel-off, transparent, self-adhesive legends	International	O	10	ZBY1146	0.017/0.037
		I	10	ZBY1147	0.017/0.037
		II	10	ZBY1148	0.017/0.037
		III	10	ZBY1149	0.017/0.037
		STOP	10	ZBY1304	0.017/0.037
	French	↑	10	ZBY1912	0.017/0.037
		ARRET	10	ZBY1104	0.017/0.037
		ARRIERE	10	ZBY1106	0.017/0.037
		AUTO	10	ZBY1115	0.017/0.037
		AVANT	10	ZBY1105	0.017/0.037
		DESCENTE	10	ZBY1108	0.017/0.037
		MAIN	10	ZBY1116	0.017/0.037
	English	MARCHE	10	ZBY1103	0.017/0.037
		MONTEE	10	ZBY1107	0.017/0.037
		HAND	10	ZBY1316	0.017/0.037
		OFF	10	ZBY1312	0.017/0.037
	German	ON	10	ZBY1311	0.017/0.037
START		10	ZBY1303	0.017/0.037	
AB		10	ZBY1208	0.017/0.037	
AUF		10	ZBY1207	0.017/0.037	
AUS		10	ZBY1204	0.017/0.037	
EIN	10	ZBY1203	0.017/0.037		
ZU	10	ZBY1214	0.017/0.037		

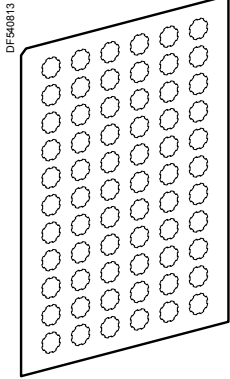

ZBY1101



ZBY2U

“SIS Label” labelling software

Application	For use with	Reference	Weight kg/lb
Legend design for English, French, German, Spanish, Italian	ZBY001, ZBY0101, ZBY0102, ZBY1101 ZBY4100, ZBY5100, ZBY5101 and ZBY5102	ZBY2U	0.100/0.220

Circular yellow legends for mushroom head pushbuttons

Used for “Emergency stop” function (1)

Diameter mm/in.	Conforming to standards	Marking on Yellow background	Sold in lots of	Reference	Weight kg/lb
60/2.362	EN/IEC 60204-1 and EN/ISO 13850	–	10	ZBY9140	0.004/0.009
		ARRET D'URGENCE	10	ZBY9130	0.004/0.009
		EMERGENCY STOP	10	ZBY9330	0.004/0.009
		NOT-HALT	10	ZBY9230	0.004/0.009
		PARADA DE EMERGENCIA	10	ZBY9430	0.004/0.009
		ARRESTO DE EMERGENZA	10	ZBY9630	0.004/0.009
		–	10	ZBY8140	0.008/0.018
90/3.543	EN/IEC 60204-1 and EN/ISO 13850	ARRET D'URGENCE	10	ZBY8130	0.008/0.018
		EMERGENCY STOP	10	ZBY8330	0.008/0.018
		NOT-HALT	10	ZBY8230	0.008/0.018
		PARADA DE EMERGENCIA	10	ZBY8430	0.008/0.018
		ARRESTO DE EMERGENZA	10	ZBY8630	0.008/0.018



ZBY9130

Used for “Emergency switching off” function

60/2.362	EN/IEC 60204-1	–	10	ZBY9101	0.004/0.009
		COUPURE D'URGENCE	10	ZBY9160	0.004/0.009
		EMERGENCY SWITCHING OFF	10	ZBY9360	0.004/0.009
		NOT-AUS	10	ZBY9260	0.004/0.009
		DESCONEXION DE EMERGENCIA	10	ZBY9460	0.004/0.009
90/3.543	EN/IEC 60204-1	–	10	ZBY8101	0.008/0.018
		COUPURE D'URGENCE	10	ZBY8160	0.008/0.018
		EMERGENCY SWITCHING OFF	10	ZBY8360	0.008/0.018
		NOT-AUS	10	ZBY8260	0.008/0.018
		DESCONEXION DE EMERGENCIA	10	ZBY8460	0.008/0.018
INTERRUZIONE DI EMERGENZA	10	ZBY8660	0.008/0.018		

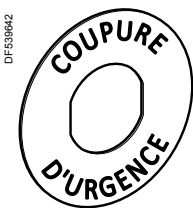

ZBY9160

(1) For complying with EN/ISO 13850 standard, paragraph 4.4.6., Emergency Stop function logo has been added.

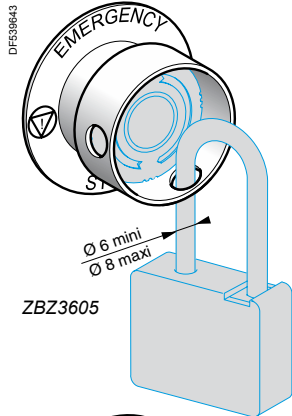

ZBZ3605



ZBY9130T

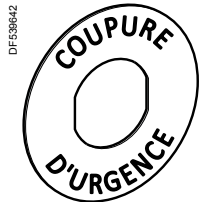

ZBY9160T

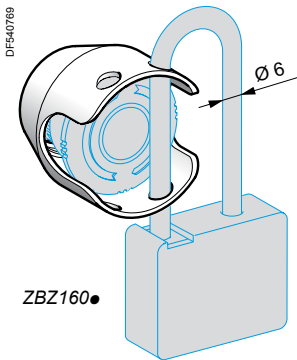

ZBZ160●

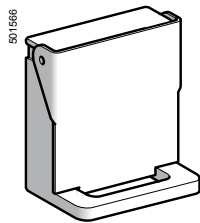

ZB4BZ64

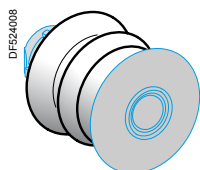

ZBZ●8

Accessories for mushroom head pushbuttons

Description	Exclusive use with the following Ø 40/1.575 in. trigger action pushbuttons	Color	Reference	Weight kg/lb
-------------	--	-------	-----------	--------------

Padlocking kit (1) (2) For Emergency stop (3) and Emergency switching off function (4), (padlockable)	XB5AS844●, XB5AS944●, ZB5AS844, ZB5AS944●.	Yellow	ZBZ3605	0.045/0.099
--	--	--------	----------------	-------------

Metal guards For Emergency stop (3) function Padlockable (2)	XB5AT8●,	Chromium plated	ZBZ1600	0.046/0.101
	XB5AS8●,	Black	ZBZ1602	0.046/0.101
	XB5AS9●,	Red	ZBZ1604	0.046/0.101
	ZB5AT8●, ZB5AS8●, ZB5AS9●.	Blue	ZBZ1606	0.046/0.101

Description	Marking	Color	Sold in lots of	Reference	Weight kg/lb
Ø 60 mm/2.363 in. legend for padlocking device ZBZ3605 For Emergency stop function (3)	Without	Yellow	–	ZBY9140T	0.004/0.009
	ARRET D'URGENCE	Yellow	–	ZBY9130T	0.004/0.009
	EMERGENCY STOP	Yellow	–	ZBY9330T	0.004/0.009
	NOT-HALT	Yellow	–	ZBY9230T	0.004/0.009
Ø 60 mm/2.363 in. legend for padlocking device ZBZ3605 For Emergency switching off function (4)	Without	Yellow	–	ZBY9101T	0.004/0.009
	COUPURE D'URGENCE	Yellow	–	ZBY9160T	0.004/0.009
	EMERGENCY SWITCHING OFF	Yellow	–	ZBY9360T	0.004/0.009
	NOT-AUS	Yellow	–	ZBY9260T	0.004/0.009
Ø 60 mm/2.363 in. circular legend compatible with Emergency stop	-	Yellow	5	ZBY9121	0.007/0.015
	EMERGENCY STOP	Yellow	5	ZBY9320	0.007/0.015
	ARRET D'URGENCE	Yellow	5	ZBY9120	0.007/0.015
	NOT-HALT	Yellow	5	ZBY9220	0.007/0.015
	PARADA DE EMERGENCIA	Yellow	5	ZBY9420	0.007/0.015
	ARRESTO DI EMERGENZA	Yellow	5	ZBY9620	0.007/0.015

Other accessories

Description	For use with	Color	Reference	Weight kg/lb
Plastic guard	Selector switches and key switches	Black	ZBZ2102	0.005/0.011
Padlockable flaps	Flush type pushbuttons	Black	ZB4BZ62	0.076/0.168
		Red	ZB4BZ64	0.076/0.168
		Yellow	ZB4BZ65	0.076/0.168
		Blue	ZB4BZ66	0.076/0.168

Description	Material	For use with	Color	Sold in lots of	Unit reference	Weight kg/lb
Bellows seals for harsh environments (Environments subject to humidity, dust, high-pressure cleaning etc...) IP 69K (5)	Silicone	Emergency stop /Switching off function	Yellow	2	ZBZ28	0.009/0.020
		Other functions	Black	2	ZBZ58	0.009/0.020

(1) Standard circular legends are not compatible with this product. Use special legends ZBY9●●●T.

(2) No isolation function is possible when this guard is fitted.

(3) Ensures conformity with standards EN/IEC 60204-1 and EN/ISO 13850.

(4) Ensures conformity with standard EN/IEC 60204-1.

(5) Only when mounted on control stations. Use legends ZBY9●●●T.



ZB5SZ3



ZB4BZ007

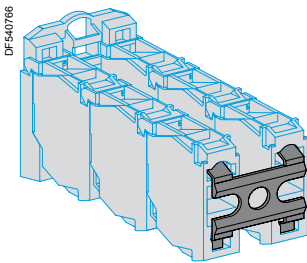

ZBZ007

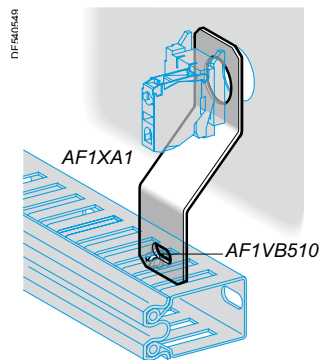

Other accessories (continued)

Description	For use with	Color	Sold in lots of	Unit reference	Weight kg/lb
Plastic blanking plug (with fixing nut)	Circular shape - Ø 22 mm/0.866 in. control and signaling units	Black	10	ZB5SZ3	0.009/0.020
	Square shape - Ø 22 mm/0.866 in. control and signaling units	Black	10	ZB5SZ5	0.009/0.020
Liquid spray protective washer to be fitted under the head	Ø 22 mm/0.866 in. control and signaling units	Chromium plated	50	ZB4BZ007	0.010/0.022
		Black	50	ZB4BZ0077	0.010/0.022
Plastic clips	2 or 3 levels of contact – blocks ZBE10● in high vibration environment		10	ZBZ007	–
Dummy contact block	Contact blocks ZBE10● and transformer blocks ZBV5B	–	5	ZBE000	–
Set of tabs for Faston connection	Contact blocks ZBE10● and light blocks ZBV●	–	10	ZBZ003	–
Cable ducting support	Fixing beneath head		10	AF1XA1	0.030/0.066
M5 x 10 screw, with hexagonal slotted head	For fixing cable ducting		100	AF1VB510	0.003/0.066
Support	Pushbuttons, switches and pilot lights		1	DX1AP52	0.160/0.353
Boot for contact block (1)	For protection against dusty environment		1	ZBZ60	0.098/0.216

(1) Restriction for use: refer to the product instruction sheet on our website www.schneider-electric.com.

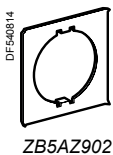
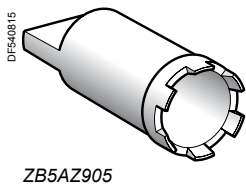
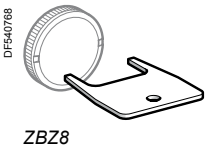
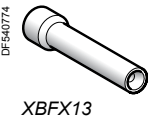

Bulbs with BA 9s base fitting and associated accessories

Illuminated pushbuttons						
Description	Characteristics	Color	Sold in lots of	Unit reference	Weight kg/lb	
LEDs	≈ 24 V	White	1	DL1CJ0241	0.002/0.004	
		Green	1	DL1CJ0243	0.002/0.004	
		Red	1	DL1CJ0244	0.002/0.004	
		Orange	1	DL1CJ0245	0.002/0.004	
		Blue	1	DL1CJ0246	0.002/0.004	
	≈ 48 V	Green	1	DL1CJ0483	0.002/0.004	
		Red	1	DL1CJ0484	0.002/0.004	
		Orange	1	DL1CJ0485	0.002/0.004	
		6 V - 1.2 W	White	1	DL1CD0061	0.002/0.004
			Green	1	DL1CD0063	0.002/0.004
Red	1		DL1CD0064	0.002/0.004		
Orange	1		DL1CD0065	0.002/0.004		
Blue	1	DL1CD0066	0.002/0.004			
	Incandescent bulbs	6 V - 1.2 W	–	10	DL1CB006	0.002/0.004
		24 V - 2 W	–	10	DL1CE024	0.002/0.004
120...130 V 2.4 W		–	10	DL1CE130	0.002/0.004	
Neon bulbs	120...130 V	–	10	DL1CF110	0.002/0.004	
	230...240 V	–	10	DL1CF220	0.002/0.004	
Bulb extractor	–	–	1	XBFX13	0.005/0.011	
Lens cap tightening tool	Illuminated pushbuttons, with flush push	–	1	ZBZ8	0.009/0.020	
Add-on square trim	Gives a square appearance to ZB5A circular heads	Black	10	ZB5AZ31	0.002/0.004	
		Green	10	ZB5AZ1715626002	0.002/0.004	
		Red	10	ZB5AZ1715626001	0.002/0.004	
		Blue	10	ZB5AZ1715626003	0.002/0.004	
Nut	Fixing ZB5A head	–	10	ZB5AZ901	0.002/0.004	
Bezel tool	Tightening head fixing nut ZB5AZ901	–	1	ZB5AZ905	0.016/0.035	
Anti-rotation plate	Selector switches and Emergency stop pushbuttons heads ZB5A	–	10	ZB5AZ902	0.008/0.018	



ZBG455



ZBDLU1



ZBG455P



ZBGP



ZBDD2

Replacement keys

Description	Key number	Reference	Weight kg/lb
For latching mushroom head pushbuttons and selector switches			
Sets of 2 keys	455	ZBG455	0.013/0.029
	421E	ZBG421E	0.014/0.031
	458A	ZBG458A	0.014/0.031
	520E	ZBG520E	0.014/0.031
	3131A	ZBG3131A	0.014/0.031
	4A185	ZBDA185	0.014/0.031
	LU1	ZBDLU1	0.014/0.031
	LU2	ZBDLU2	0.014/0.031
	LU3	ZBDLU3	0.014/0.031
	LU4	ZBDLU4	0.014/0.031
	LU5	ZBDLU5	0.014/0.031
	LU6	ZBDLU6	0.014/0.031
	LU7	ZBDLU7	0.014/0.031
	LU8	ZBDLU8	0.014/0.031
	LU9	ZBDLU9	0.014/0.031
	LU10	ZBDLU10	0.014/0.031
	LU11	ZBDLU11	0.014/0.031
	LU12	ZBDLU12	0.014/0.031
	LU13	ZBDLU13	0.014/0.031
	LU14	ZBDLU14	0.014/0.031
	8D1	ZBD8D1	0.014/0.031
	Specific key	ZBGK (1)	0.014/0.031

For booted selector switches

Sets of 2 keys, one of which supplied booted (rubber boot)	455	ZBG455P	–
	421E	ZBG421EP	–
	458A	ZBG458AP	–
	520E	ZBG520EP	–
	3131A	ZBG3131AP	–

Accessory for key switches (2)

Description	Function	Reference	Weight kg/lb
Keyhole cover (rubber boot)	Protection of lock barrel when no key inserted in lock	ZBGP	0.005/0.011

Boot for standard handle

Description	For use with	Sold in lots of	Unit reference	Weight kg/lb
Boot for standard handle	ZB4BD●● and ZB5AD●●	5	ZBDD2	0.005/0.011

(1) Key number to be added when ordering.

(2) Not compatible with products with key TEC10.

ZBE10263	44	ZBY021●●	58	ZBZ012	43
ZBG421E	65	ZBY22●●	57	ZBZ28	27
ZBG421EP	65	ZBY022●●	59		62
ZBG455	65	ZBY23●●	56	ZBZ3●	56
ZBG455P	65		57		60
ZBG458A	65	ZBY023●●	59	ZBZ58	27
ZBG458AP	65	ZBY2931	56		62
ZBG520E	65	ZBY02931	58	ZBZ60	63
ZBG520EP	65	ZBY4100	59	ZBZ160●	62
ZBG2201	39	ZBY4101	56	ZBZG156	41
ZBG2401	39	ZBY4140	56	ZBZM156	41
ZBG3131A	65	ZBY51●●	60	ZBZVG	41
ZBG3131AP	65	ZBY61●●	60	ZBZVM	41
ZBG4201	39	ZBY81●●	61	ZD5PA12	39
ZBG4401	39	ZBY82●●	61	ZD5PA14	39
ZBGK	65	ZBY83●●	61	ZD5PA22	39
ZBGP	65	ZBY84●●	61	ZD5PA24	39
ZBL●	52	ZBY86●●	61	ZD5PA103	39
ZBL138	53	ZBY9101	61	ZD5PA203	39
ZBP0	54	ZBY9101T	62		
ZBP0A	54	ZBY9120	27		
ZBP01●	54		62		
ZBPA	54	ZBY9121	27		
ZBV5B	41		62		
ZBV6	51	ZBY9130	61		
ZBV01●	55	ZBY9130T	62		
ZBV18B●	41	ZBY9140	61		
ZBV18G●	41	ZBY9140T	62		
ZBV18M●	41	ZBY9160	61		
ZBV0103S	55	ZBY9160T	62		
ZBV01●●	55	ZBY9220	27		
ZBVB●	41		62		
ZBVB●●	41	ZBY9230	61		
	42	ZBY9230T	62		
	43	ZBY9260	61		
	45	ZBY9260T	62		
ZBVG●	41	ZBY9320	27		
ZBVG●●	42		62		
	45	ZBY9330	61		
ZBVJ●	41	ZBY9330T	62		
ZBVJ●●	42	ZBY9360	61		
ZBVM●	41	ZBY9360T	62		
ZBVM●●	42	ZBY9420	27		
	45		62		
ZBW9●●	55	ZBY9430	61		
ZBW9●●●	55	ZBY9460	61		
ZBY001	40	ZBY9620	27		
	42		62		
	44	ZBY9630	61		
ZBY2H101	56	ZBY9660	61		
ZBY4H101	56	ZBY55130	60		
ZBY6H101	60	ZBY55330	60		
ZBY6H102	60	ZBY22420001	57		
ZBY01●●	56	ZBY022420001	59		
	58	ZBZ001	40		
ZBY00104	58		44		
ZBY00123	58	ZBZ003	63		
ZBY11●●	61	ZBZ006	43		
ZBY12●●	61	ZBZ007	63		
ZBY13●●	61	ZBZ8	64		
ZBY1912	61	ZBZ010	43		
ZBY21●●	56	ZBZ011	43		



Schneider Electric Industries SAS

Head Office
35, rue Joseph Monier
F-92500 Rueil-Malmaison
France

www.schneider-electric.com/control

The information provided in this documentation contains general descriptions and/or technical characteristics of the performance of the products contained herein. This documentation is not intended as a substitute for and is not to be used for determining suitability or reliability of these products for specific user applications. It is the duty of any such user or integrator to perform the appropriate and complete risk analysis, evaluation and testing of the products with respect to the relevant specific application or use thereof. Neither Schneider Electric nor any of its affiliates or subsidiaries shall be responsible or liable for misuse of the information contained herein.

Design: Schneider Electric
Photos: Schneider Electric
Printed by: